



Declaration of Conformity



Type of equipment: NETWORK CAMERA
Brand Name /Trade Mark: SAMSUNG
Type designation /model: SNV-L6083RP
Applicant: Samsung Techwin Co., Ltd.

In accordance with the following Directives:

2004/108/EC The Electromagnetic Compatibility Directive
Including amendments by the CE Marking Directive 93/68/EEC

2011/65/EU Restriction of the use of certain hazardous substances in electrical and electronic equipment (recast)

The following harmonized European standards or technical specifications have been applied:

EN 55022:2010 Limits and methods of measurement of radio disturbance characteristics of information technology equipment
EN 50581:2012 Technical documentation for the assessment of electrical and electronic products with respect to the restriction of hazardous substances
EN 55024:2010 Information technology equipment-Immunity characteristics-Limits and methods of measurement
EN 61000-4-2:2009 Electrostatic discharge immunity test
EN 61000-4-3:2006+A2:2010 Radiated, radio-frequency, electromagnetic field immunity test
EN 61000-4-4:2012 Electrical fast transient/burst immunity test
EN 61000-4-6:2009 Immunity to conducted disturbances, induced by radio-frequency fields

The CE Marking on the products and/or their packaging signifies that SAMSUNG TECHWIN CO., LTD. holds the reference technical file available to the European Union authorities.

Place and date of issue: 84, Jeongdong-ro, Seongsan-gu, Changwon-si, Gyeongsangnam-do, Korea / Feb 27, 2015

Authorized Signatory: Name : Jei Soon, Kang
Title : Principal Research Engineer

Signature :

CE Conformance EMC Test Report

Test Report No. : KES-E1-15T0058
Date of Issue : 02. 27. 2015
Description of Product : NETWORK CAMERA
Model No. : SNV-L6083RP
Variant Model : -
Applicant : Samsung Techwin Co., Ltd.
Address : 84, Jeongdong-ro, Sengsan-gu, Changwon-si, Gyeongsangnam-do, Korea
Manufacturer : TIANJIN SANSUNG TECHWIN OPTO-ELECTRONIC CO.,LTD
Address : No.11 Weiliu Road, Micro-Electronic Industrial Park, Jingang Road,Tianjin, 300385, China
Applicable Regulation : **EMC Directive 2004/108/EC**
EN 55022:2010
EN 50130-4:2011
EN 6100-3-2
EN 6100-3-3

Date of Receipt : 02. 05. 2015
Test Date : 02. 10. 2015 ~ 02. 16. 2015

Tested by:Tae Yeon, Kim
Test Engineer**Reviewed by:**Dong Hun, Jang
Technical Manager

Testing Laboratories for Safety and RF Compliance
C-3701 40, Simin-daero 365beon-gil, Dongan-gu, Anyang-si, Gyeonggi-do, 431-716, Korea
Tel: +82-31-425-6200 / Fax: +82-31-424-0450

Testing Laboratories for EMC Compliance
473-29, Gayeoro, Yeosu-si, Gyeonggi-do, 469-803, Korea
Tel : +82-31-883-5092 / Fax: +82-31-883-5169



KES Co., Ltd.

C-3701, 40, Simin-daero 365beon-gil,
Dongan-gu, Anyang-si, Gyeonggi-do, 431-716, Korea
Tel: +82-31-425-6200 / Fax: +82-31-424-0450
www.kes.co.kr

Test report No.:
KES-E1-15T0058
Page (2) of (65)

Revision history

Revision	Date of issue	Test report No.	Description
-	02. 26. 2015	KES-E1-15T0058	Initial

This report shall not be reproduced except in full, without the written approval of KES Co., Ltd.
The test results in the report only apply to the tested sample.

TABLE OF CONTENTS

1	General Information	4
2	Product Labelling Requirements	19
3	Applicable Regulations	10
4	Test standards and results	13
5	Test Performed	14
	5.1 Conducted Emission Measurements	14
	5.2 Radiated Emission Measurements	21
	5.3 Harmonics / Voltage Fluctuations Measurements	29
	5.4 Electrostatic Discharge Immunity	33
	5.5 Radio-frequency electromagnetic field Amplitude modulated Immunity	35
	5.6 Fast Transients Immunity	38
	5.7 Surge Immunity	41
	5.8 Radio-frequency continuous conducted Immunity	43
	5.9 Voltage Dips and Interruptions Immunity	45
6	Test Setup Photographs	47
	6.1 Conducted Emission	47
	6.2 Radiated Emission	49
	6.3 Harmonics / Voltage Fluctuations Measurements	51
	6.4 Electrostatic Discharge Immunity	52
	6.5 Radio frequency electromagnetic field immunity	54
	6.6 Fast Transients Immunity	54
	6.7 Surge Immunity	55
	6.8 Radio-frequency continuous conducted Immunity	55
	6.9 Voltage Dips and Interruptions Immunity	56
7	External Photographs	57
8	Internal Photographs	59
	Appendix A -Schematics/Block Diagram	64
	Appendix B - User's Manual	65



1. General Information

1.1 Introduction

The EMC Test Report for CE Declaration of Conformity is prepared on behalf of named applicant in accordance with the EMC Directive(2004/108/EC) of the European Economic Community. The test results reported in this document relate only to the item that was tested.

All radiated emission, conducted emission measurements required by the EMC Directive were performed manually at KES Co., Ltd. (here in after called KES), 473-29, Gayeo-ro, Yeosu-si, Gyeonggi-do, 469-803 KOREA.

The radiated emission measurements performed on 10 meter, Open Area Test Site, test range maintained by KES. Complete ANSI63.4;2009 description and site attenuation measurement data records are maintained at the test facility and have been placed on file with the Federal Communications Commission.

All immunity measurements required by the EMC Directive were performed manually at KES Co., Ltd. (here in after called KES), 473-29, Gayeo-ro, Yeosu-si, Gyeonggi-do, 469-803 KOREA.

The immunity measurements were performed in a shielded enclosure and/or anechoic chamber also located at the same facility.

The KES EMC test facilities in Yeosu-si are designated testing laboratory according to ISO/IEC 17025 by Radio Research Agency(RRA), Korea Communication Commission.

1.2 Product Description for Equipment Under Test (E.U.T)

Samsung Techwin Co., Ltd., NETWORK CAMERA, Model No: SND-L6083RP or the "E.U.T" as referred to in this report is base model.

Main Specifications of EUT are:

Video	
Imaging Device	1/2.9" 2.19M CMOS
Total Pixels	2,000(H) x 1,121(V)
Effective Pixels	1,984(H) x 1,105(V)
Scanning System	Progressive
Min. Illumination	Color:0.15Lux(1/30sec,F1.4,50IRE),0.0025Lux(2sec,50IRE) Color:0.095Lux(1/30sec,F1.4,30IRE) B/W : 0 Lux (IR LED on)
Lens	
Focal Length (Zoom Ratio)	3~10mm V/F
Max. Aperture Ratio	F1.4
Angular Field of View	H:103.8°(Wide)~32.4°(Tele)(±5%),V:53.7°(Wide)~18.4°(Tele)(±5%), D:121.9°(Wide)~37.1°(Tele)(±5%)
Min. Object Distance	0.5m
Focus Control	Manual
Lens Type	DC auto iris
Mount Type	Board type
Pan / Tilt / Rotate	
Pan Range	0~350°
Tilt Range	0~67°
Rotate Range	0~355°
Operational	
IR Viewable Length	15m
Camera Title	Off / On (Displayed up to 15 characters)
Day & Night	True Day & Night
Backlight Compensation	Off / BLC
Contrast Enhancement	SSDR(SamsungSuperDynamicRange) (Off / On)
Digital Noise Reduction	SSNR(Off / On)
Motion Detection	Off / On (4ea rectangular zones)
Privacy Masking	Off / On (6ea rectangular zones)
Gain Control	Off / Low / Middle / High
White Balance	ATW / AWC / Manual / Indoor / Outdoor
LDC(Lens distortion control)	On/Off (5 levels with Min/Max)
Electronic Shutter Speed	Minimum / Maximum / Anti flicker
Flip / Mirror	Flip / Mirror / Hallway view
Intelligent Video Analytics	Motion Detection with metadata, Tampering
Alarm Triggers	Motiondetection, Tampering Detection, SD card error
Alarm Events	FileuploadviaFTPandE-Mail LocalstoragerecordingatEvent NotificationviaE-Mail
Network	
Ethernet	RJ-45 (10/100BASE-T)
Video Compression Format	H.264, MJPEG
Resolution	1920x1280 /1280x960 / 1280x720 / 1024x768 /800x600 / 720x576 / 640x480 / 320x240
Max. Framerate	H.264:Max30fpsatallresolutions MJPEG:Max1fpsat1920x1080/1280x1024/1280x720/1024x768,Max.15fpsatother resolution
Video Quality Ajustment	H.264:TargetBitrateLevelControl MJPEG:QualityLevelControl
Bitrate control method	H.264:CBRorVBR

This report shall not be reproduced except in full, without the written approval of KES Co., Ltd.
The test results in the report only apply to the tested sample.



KES Co., Ltd.

C-3701, 40, Simin-daero 365beon-gil,
 Dongan-gu, Anyang-si, Gyeonggi-do, 431-716, Korea
 Tel: +82-31-425-6200 / Fax: +82-31-424-0450
 www.kes.co.kr

Test report No.:
 KES-E1-15T0058
 Page (6) of (65)

	MJPEG:VBR
Streaming Capability	Multiple Streaming(Up to 3 Profiles)
Audio I/O	Line-in
Audio Compression Format	G.711u-law/G.726Selectable G.726(ADPCM)8KHz,G.7118KHz G.726:16Kbps,24Kbps,32Kbps,40Kbps
Audio Communication	Uni-directional
IP	IPv4, IPv6
Protocol	TCP/IP,UDP/IP,RTP(UDP),RTP(TCP),RTCP,RTSP,NTP,HTTP,HTTPS,SSL,DHCP,PPPoE,FTP,SMTP,ICMP,IGMP, ,SNMPv1/v2c/v3(MIB-2),ARP,DNS,DDNS,QoS,PIM-SM,UPnP,Bonjour
Security	HTTPS(SSL)LoginAuthentication DigestLoginAuthentication IPAddressFiltering UseraccessLog 802.1XAuthentication
Streaming Method	Unicast / Multicast
Max. User Access	6 users at Unicast Mode
Edge storage	MicroSD/SDHCMax32G,NAS (Motionimagesrecorded in theSDmemorycardcanbedownloaded) (ManualrecordingatLocalPC)
Application Programming Interface	ONVIFProfileS,G SUNAPI(HTTPAPI)
Webpage Language	English,French,German,Spanish,Italian,Chinese,Korean, Russian,Japanese,Swedish,Denish,Portuguese,Turkish,Polish,Czech,Rumanian,Serbian,Dutch,Croatia, Hungary,Greek,Finnish,Norwegian
Web Viewer	SupportedOS:WindowsXP/VISTA/7/8/8.1,MACOSX10.7~10.10 SupportedBrowser:MicrosoftInternetExplorer(Ver.8~11),MozillaFirefox(Ver.9~35), Google Chrome (Ver. 15~40), Apple Safari (Ver. 8.0.2(Mac OS X 10.10), 8.0.2(Mac OS X 10.9), 6.0.2 (Mac OS X 10.8, 10.7 only), 5.1.7) * Mac OS X only
Central Management Software	SmartViewer
Environmental	
Operating Temperature / Humidity	-30° C ~ +55° C / Less than 90% RH
Storage Temperature / Humidity	-30° C~+60° C(-22° F~+140° F)/ Less than 90% RH
Ingress Protection	IP66
Vandal Resistance	IK10
Electrical	
Input Voltage / Current	PoE
Power Consumption	Max. 7.0W
Mechanical	
Color / Material	Ivory / Metal
Dimension (WxHxD)	Ø137 x H106.1
Weight	655g

This report shall not be reproduced except in full, without the written approval of KES Co., Ltd.
 The test results in the report only apply to the tested sample.

1.3 Equipment Under Test

Description	Model Number	Serial Number	Manufacturer	Remarks
NETWORK CAMERA	SND-L6083RP	-	TIANJIN SAMSUNG TECHWIN OPTO-ELECTRONIC CO., LTD	E.U.T

1.4 Support Equipments

Description	Model Number	Serial Number	Manufacturer	Remarks
Notebook	NT-R410Y	Z9YJ93CS300631 H	Samsung Electronics	-
AC/DC Adaptor	AD-6019	-	LI SHIN INTERNATIONAL ENTERPRISE CORP.	-
POE Switch	FDS-804PS(V3)	A310129100013	PLANET Technology Corp.	-
Micro SD Card	-	-	SANDISK	-

1.5 External I/O Cabling

Description	Length (m)	Port / From	Port/To	Remarks
NETWORK CAMERA	-	Micro SD slot / Micro SD Card	Micro SD Card slot / EUT	-
NETWORK CAMERA	3.0	RJ-45 / EUT	RJ-45 / POE Switch	Unshielded
POE Switch	2.5	RJ-45 / POE Switch	RJ-45 / Notebook	Unshielded

1.6 Special Accessories

As shown in section 1.8, all interface cables used for compliance testing are shielded as normally supplied or by use respective component manufacturers.

1.7 E.U.T Modifications

No modifications were made to the E.U.T in order to achieve and maintain compliance to the standards described in this report.

1.8 Configuration of Test System

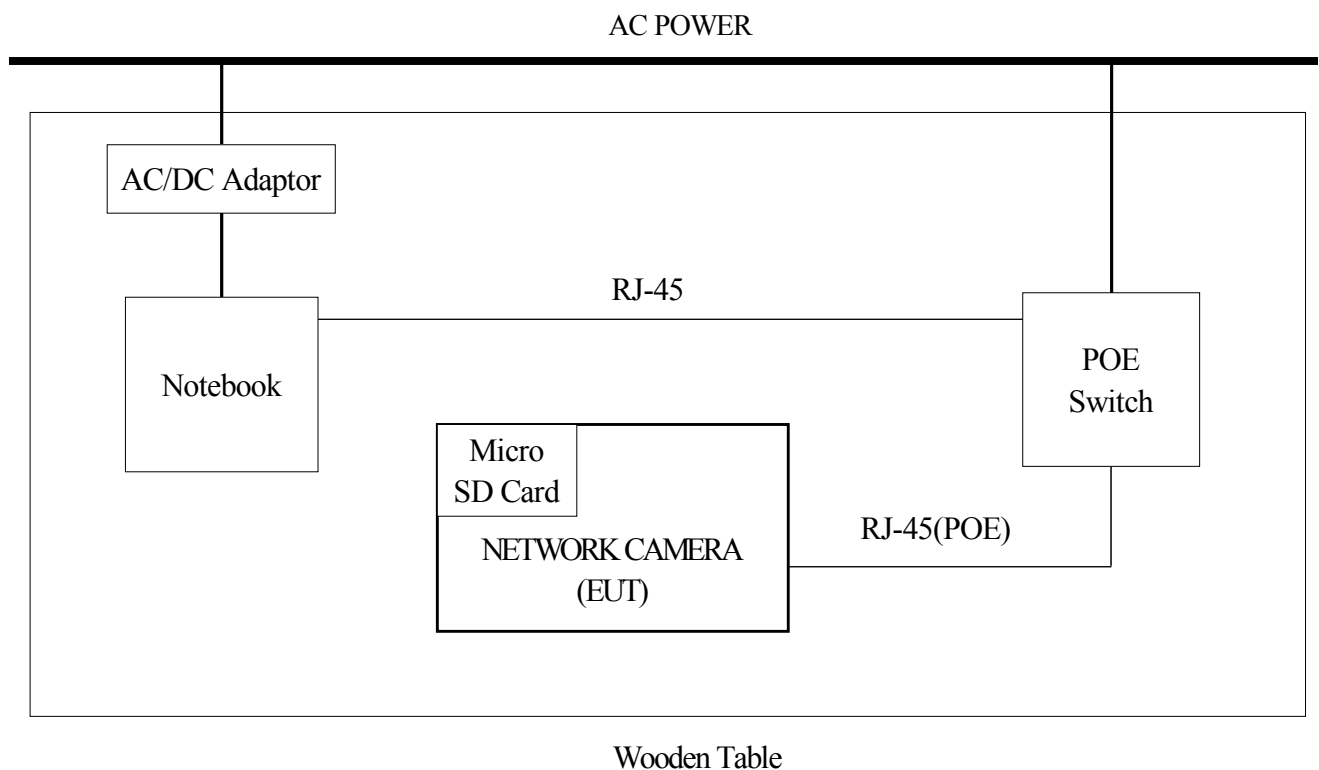

1.9 Operating condition :

- Ping test
- web view monitoring

2. Product Labelling Requirements

2.1 CE Mark

The CE Conformity Marking must consist of the initials "CE" in the stylized font and proportional to the dimensional requirements shown in following figure. Regardless of its size, the symbol must retain the specified proportionality.

The Various components of the CE Marking must have substantially the same vertical dimensions, and shall not be less than 5mm in height.

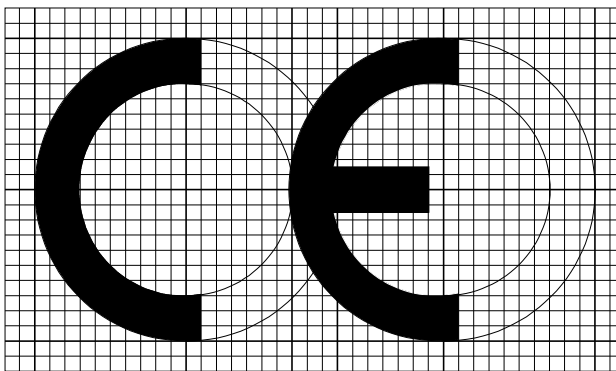

Radius of Outer Circle 100 units
Radius of Inner Circle 70 units
Stroke Width 30 units
Length of Bar 85 units
Axis to Axis 170 units
Minimum Height 5.0 mm

2.2 Statements and User Information

Equipment classification, Class (A)

Directives in which conformance is claimed Applicable EN standards

Transitional provisions Class A equipment shall also include the following statement:

Warning:

This is a Class A product. In a domestic environment this product may cause radio interference in which case the user may be required to take adequate measures.

3. Applicable Regulations

3.1 Emission

EN 55022:2010/CISPR22 are the applicable regulations that apply to Information Technology Equipment. The intention of these standards, is to establish uniform requirements for the radio disturbance level of the equipment contained in the scope, to fix limits of disturbance, to describe method of measurement and to standardize operation conditions and interpretation of the results.

EN 55022:2010/CISPR22 defines Information Technology Equipment (ITE) as follows:

Any equipment which has a primary function of either (or a combination of) entry, storage, display, retrieval, transmission, processing, switching, or control, of data and of telecommunication message and which may be equipped with one or more terminal ports typically operated for information transfer.

Any equipment with a rated supply voltage not exceeding 600 V (ac)

3.2 Immunity

EN 50130-4:2011 Alarm systems-Part 4: Electromagnetic compatibility Product family standard: Immunity requirements for components of fire, intruder and social alarm systems

The variety and the diversity of the apparatus within the scope of this document makes it difficult to define precise criteria for the evaluation of the immunity test results.

If as a result of the application of the tests defined in this standard, the apparatus becomes dangerous or unsafe then the apparatus shall be deemed to have failed the test.

A functional description and a definition of performance by the manufacture and noted in the test report, based on the following criteria:

Electrostatic discharge

There shall be no damage, malfunction or change of status due to the conditioning.

Flickering of an indicator during the application of discharge is permissible, providing that is no residual change in the EUT or any change in outputs, which could be interpreted by associated equipment as a change.

Radiated electromagnetic fields

There shall be no damage, malfunction or change of status due to the conditioning.

Flickering of an indicator during the application of discharge is permissible, providing which could be interpreted by associated equipment as a change, and no such

Flickering of indicators occurs at a field strength of 3 V/m.

For components of CCTV systems, where the picture is allowed at 10 V/m, providing.

- (a) there is no permanent damage or change to EUT
(e.g. no corruption of memory or changes to programmable setting etc.)
- (b) at 3 V/m, any deterioration of the picture is so minor that the system could still be used; and
- (c) there is no observable deterioration of the picture at 1 V/m.

Fast transient burst / slow high energy voltage surge

There shall be no damage, malfunction or change of status due to the conditioning.

Flickering of an indicator during the application of discharge is permissible, providing

That there is no residual is permissible, providing that there is no residual change in the EUT or any change in outputs, which could be interpreted by associated equipment as a change.

Conducted RF immunity

There shall be no damage, malfunction or change of status due to the conditioning.

Flickering of an indicator during the application of discharge is permissible, providing

That there is no residual is permissible, providing that there is no residual change in the EUT or any change in outputs, which could be interpreted by associated equipment as a change,

and no such flickering of indicators occurs at $U = 130 \text{ dB}\mu\text{V}$.

For component of CCTV systems, where the status is monitored by observing the TV picture, then deterioration of the picture is allowed at $U = 140 \text{ dB}\mu\text{V}$, providing:

- (a) there is no permanent damage or change to the EUT
(e.g. no corruption of memory or changes to programmable settings etc.)
- (b) at $U = 130 \text{ dB}\mu\text{V}$, any deterioration of the picture is so minor that the system could still be used; and
- (c) there is no observable deterioration of the picture at $U = 120 \text{ dB}\mu\text{V}$.

Voltage dip/interruption / Voltage variation

There shall be no damage, malfunction or change of status due to the conditioning.

Flickering of an indicator during the conditioning is permissible, providing that there is no residual change in the EUT or any change in outputs, which could be interpreted by associated equipment as a change. The EUT shall meet the acceptance criteria for the functional test, after the conditioning.

4. Test standards and results

STANDARDS		LIMIT	RESULTS
EN 55022	Conducted Emission on AC mains Port	Refer to EN 55022	N/A(1)
	Conducted Emission on Telecommunication Port	Refer to EN 55022	PASS
	Radiated Emission	Refer to EN 55022	PASS
EN 61000-3-2	Harmonic Current Emission on AC Mains Input Port	Refer to EN 61000-3-2	N/A(1)
EN 61000-3-3	Voltage Fluctuations and Flicker on AC Mains Input Port	Refer to EN 61000-3-3	N/A(1)
EN 50130-4	Electrostatic Discharge Immunity	Refer to EN 61000-4-2 (Criterion B)	PASS
	Radio-frequency electromagnetic field Amplitude modulated Immunity	Refer to EN 61000-4-3 (Criterion A)	PASS
	Fast Transients Immunity	Refer to EN 61000-4-4 (Criterion B)	PASS
	Surges Immunity	Refer to EN 61000-4-5 (Criterion B)	PASS
	Radio-frequency common mode Immunity	Refer to EN 61000-4-6 (Criterion A)	PASS
	Voltage Dips, Voltage Interruptions Immunity	Refer to EN 61000-4-11 (Criterion B,C)	N/A(1)
	Voltage Variations Immunity	(Criterion A)	N/A(1)

※ Note.

(1) N/A : This device is operate by POE power. Test is not applicable.

5. Test Performed

5.1 Conducted Emission Measurements

5.1.1 Test Description

The power line conducted emission measurements were performed in a shielded enclosure. The E.U.T was placed on a wooden table, 80 centimeters height above the floor. Power was fed to the E.U.T through a 50 ohm/ 50 micro henry Line Impedance Stabilization Network (LISN). The ground plane that was electrically bonded to the shield room ground system and all power lines entering the shield room were filtered.

5.1.2 Test Equipments

Description	Manufacturer	Model Number	Serial Number	Cal. Due
EMI Receiver/Signal Analyzer	Narda S.T.S / PMM	PMM 9010F	020WW31006	04. 04. 2015
LISN	R&S	ENV216	101137	02. 10. 2016
LISN	EMCO	3810/2	2228	-
8-Wire ISN CAT3	Schwarzbeck Mess	CAT3 8158	8158-0019	04.08.2015
8-Wire ISN CAT5	Schwarzbeck Mess	NTFM 8158	8158-0030	05.21.2015
8-Wire ISN CAT6	Schwarzbeck Mess	NTFM 8158	8158-0029	08.15.2015
Electro wave Shieldroom	SEMITEC	-	-	-

5.1.3 Test Environments

Ambient Temperatures	Relative Humidity
see the data	see the data

5.1.4 Test Limits

- AC Main

Frequency (MHz)	EN 55022			
	Class B (dB μ V)		Class A (dB μ V)	
	Quasi-peak	Average	Quasi-peak	Average
0.15 to 0.50	66.0 to 56.0	56.0 to 46.0	79.0	66.0
0.50 to 5.00	56.0	46.0	73.0	60.0
5.00 to 30.00	60.0	50.0	73.0	60.0

- Telecommunication

Frequency (MHz)	EN 55022(Voltage)			
	Class B (dB μ V)		Class A (dB μ V)	
	Quasi-peak	Average	Quasi-peak	Average
0.15 to 0.50	84.0 to 74.0	74.0 to 64.0	97.0 to 87.0	84.0 to 74.0
0.50 to 30.00	74.0	64.0	87.0	74.0

Frequency (MHz)	EN 55022(Current)			
	Class B (dB μ A)		Class A (dB μ A)	
	Quasi-peak	Average	Quasi-peak	Average
0.15 to 0.50	40.0 to 30.0	30.0 to 20.0	53.0 to 43.0	40.0 to 30.0
0.50 to 30.00	30.0	20.0	43.0	30.0

5.1.5 Test Procedure

The conducted emission levels were measured on each current-carrying line with the spectrum analyzer operating in the CISPR quasi-peak mode (or peak mode if applicable). The analyzer's 6 dB bandwidth was set to 9 kHz. The initial step in collecting conducted data is a spectrum analyzer peak scan of the measurement range. If the conducted emission exceed the average limit with the instrument set to the quasi-peak mode, the measurements are made in the average mode. The emission spectrum was scanned from 150 kHz to 30 MHz. The highest emission amplitudes relative to the appropriate limits were measured and have been recorded. Quasi-peak readings are distinguished with a "QP".

The conducted emission test was performed with the E.U.T exercise program loaded, and the emissions were scanned between 150 kHz to 30 MHz on the HOT side and NEUTRAL side, herein referred to as H and N, respectively.

5.1.6 Test Results

According to the data in section 5.1.7, the E.U.T complied with the EN 55022/CISPR22 standards.



5.1.7 Test Data

* AC Power

Temperature: ℃ Humidity: % R.H. Test Date: Tested by:

Polarization: HOT

N/A



KES Co., Ltd.

C-3701, 40, Simin-daero 365beon-gil,
Dongan-gu, Anyang-si, Gyeonggi-do, 431-716, Korea
Tel: +82-31-425-6200 / Fax: +82-31-424-0450
www.kes.co.kr

Test report No.:
KES-E1-15T0058
Page (17) of (65)

Polarization: NEUTRAL

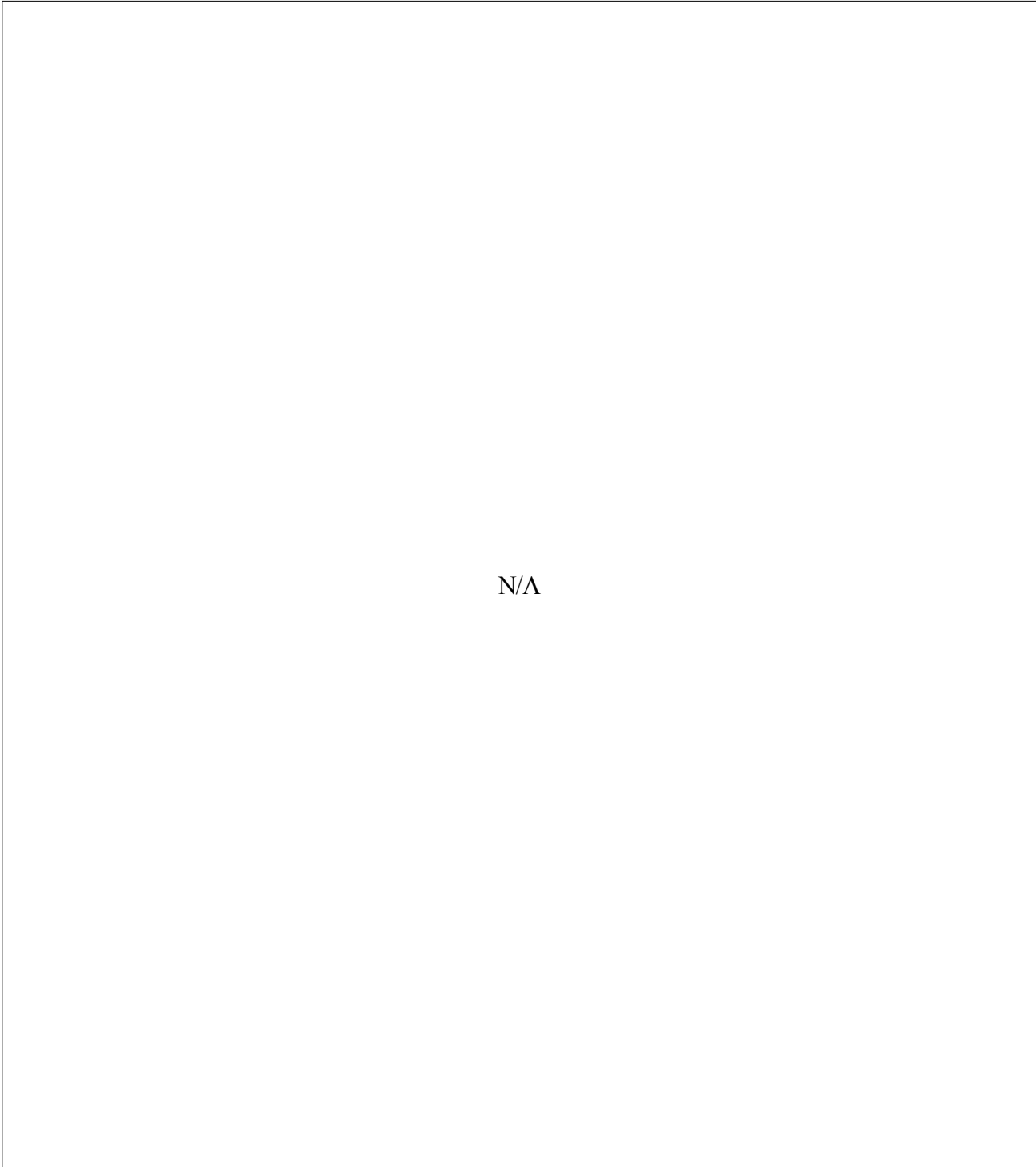

N/A

This report shall not be reproduced except in full, without the written approval of KES Co., Ltd.
The test results in the report only apply to the tested sample.



- Telecommunication

Temperature: 24.5 °C Humidity: 33.1 % R.H. Test Date: 02. 12. 2015 Tested by: Tae Yeon, Kim

[10 Mbps]

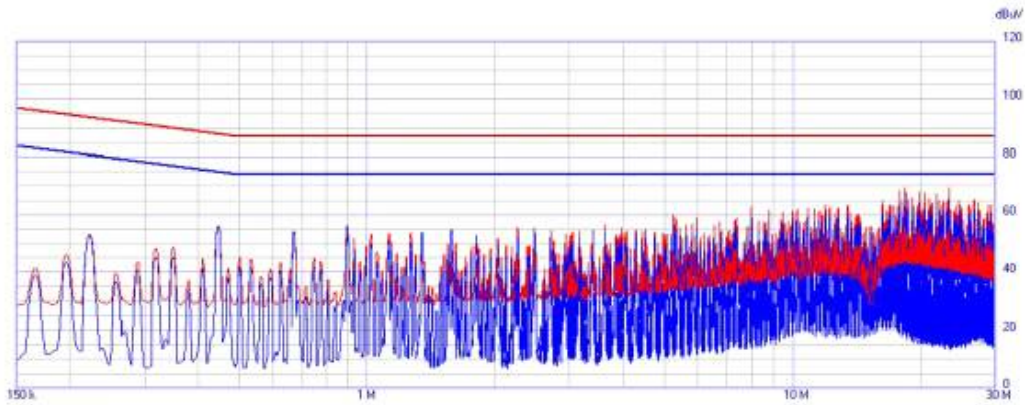

Start [MHz]	Stop [MHz]	Step	Detector	Hold Time	RBW	Min.Alt	Pre Amp	Pre Sel	Prompt stat	Ancillary
0.15	30	AUTO (2.045 kHz)	P Q C KN22-CE_TEL KN22-CE_TEL_A	1500ms	9 kHz	0	ON	ON		

Pulse Limiter ON
 Ancillary = General
 -Limit:
 55002-CE_TEL_A_QP
 55002-CE_TEL_A_AV

Factors:
 R_ISN 10 Mbps(1400408)_ISN ONLY
 CABLELOSS(1411.22)

QPeak — (red line)
 CAvg — (blue line)

10 Mbps

Frequency [MHz]	Q-Peak [dBμV]	Limit [dBμV]	Margin [dB]	C-Avg [dBμV]	Limit [dBμV]	Margin [dB]	Factor (ISN) [dB]	Factor (Cable Loss) [dB]
0.197	45.990	94.730	-48.740	43.510	81.730	-38.220	10.200	0.030
0.224	53.190	93.680	-40.490	52.890	80.680	-27.790	10.180	0.030
0.318	48.390	90.770	-42.380	45.070	77.770	-32.700	10.110	0.030
0.348	48.520	90.000	-41.480	45.130	77.000	-31.870	10.090	0.030
0.447	55.790	87.940	-32.150	56.170	74.940	-18.770	10.040	0.030
17.708	68.320	87.000	-18.680	64.890	74.000	-9.110	9.870	0.240
18.281	69.310	87.000	-17.690	65.910	74.000	-8.090	9.870	0.230
19.792	67.950	87.000	-19.050	64.520	74.000	-9.480	9.860	0.210
20.324	67.620	87.000	-19.380	64.210	74.000	-9.790	9.860	0.200
23.203	69.330	87.000	-17.670	65.880	74.000	-8.120	9.870	0.240

This report shall not be reproduced except in full, without the written approval of KES Co., Ltd.
 The test results in the report only apply to the tested sample.

[100 Mbps]

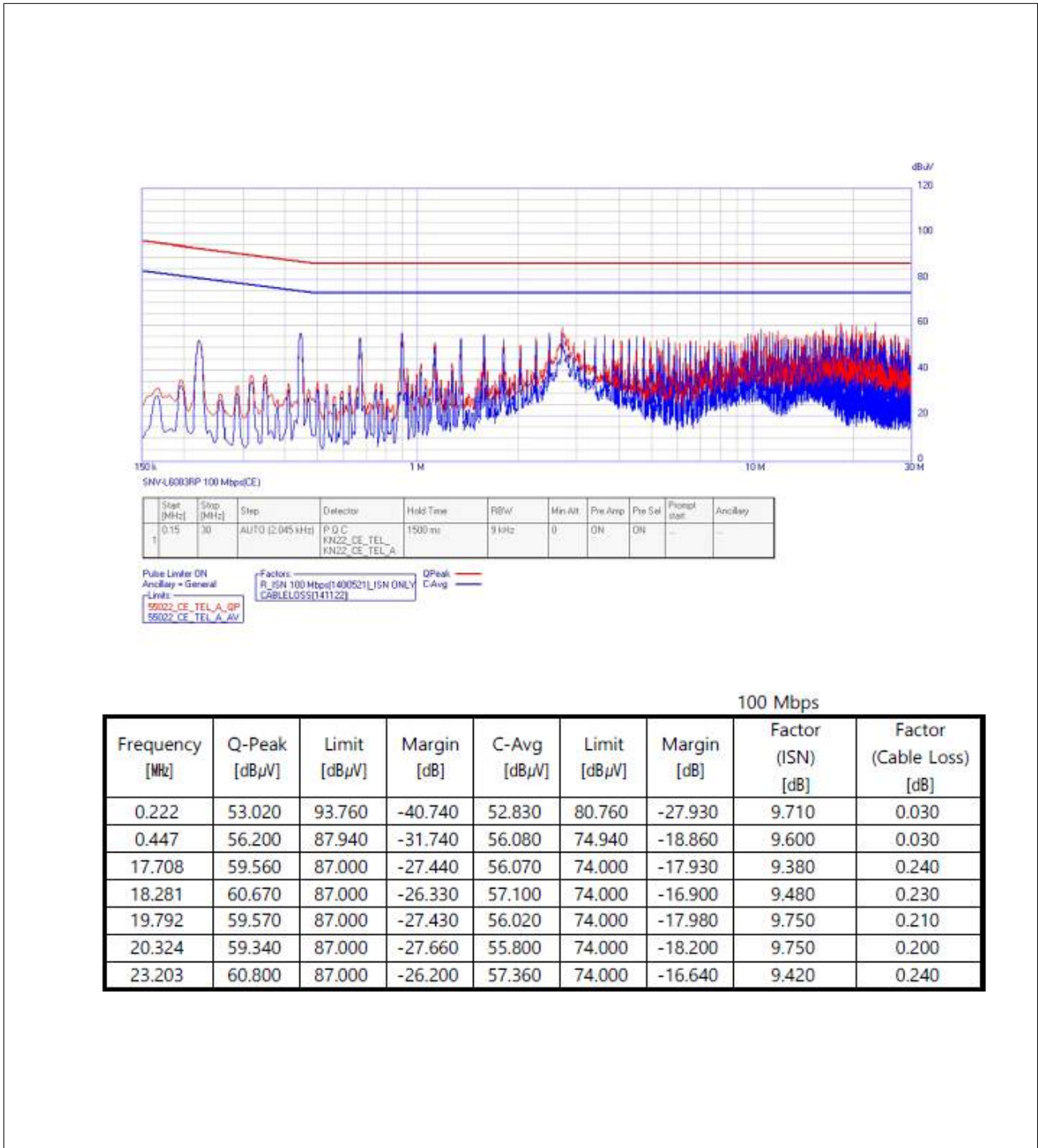

This report shall not be reproduced except in full, without the written approval of KES Co., Ltd.
 The test results in the report only apply to the tested sample.



KES Co., Ltd.

C-3701, 40, Simin-daero 365beon-gil,
Dongan-gu, Anyang-si, Gyeonggi-do, 431-716, Korea
Tel: +82-31-425-6200 / Fax: +82-31-424-0450
www.kes.co.kr

Test report No.:
KES-E1-15T0058
Page (20) of (65)

[1 000 Mbps]

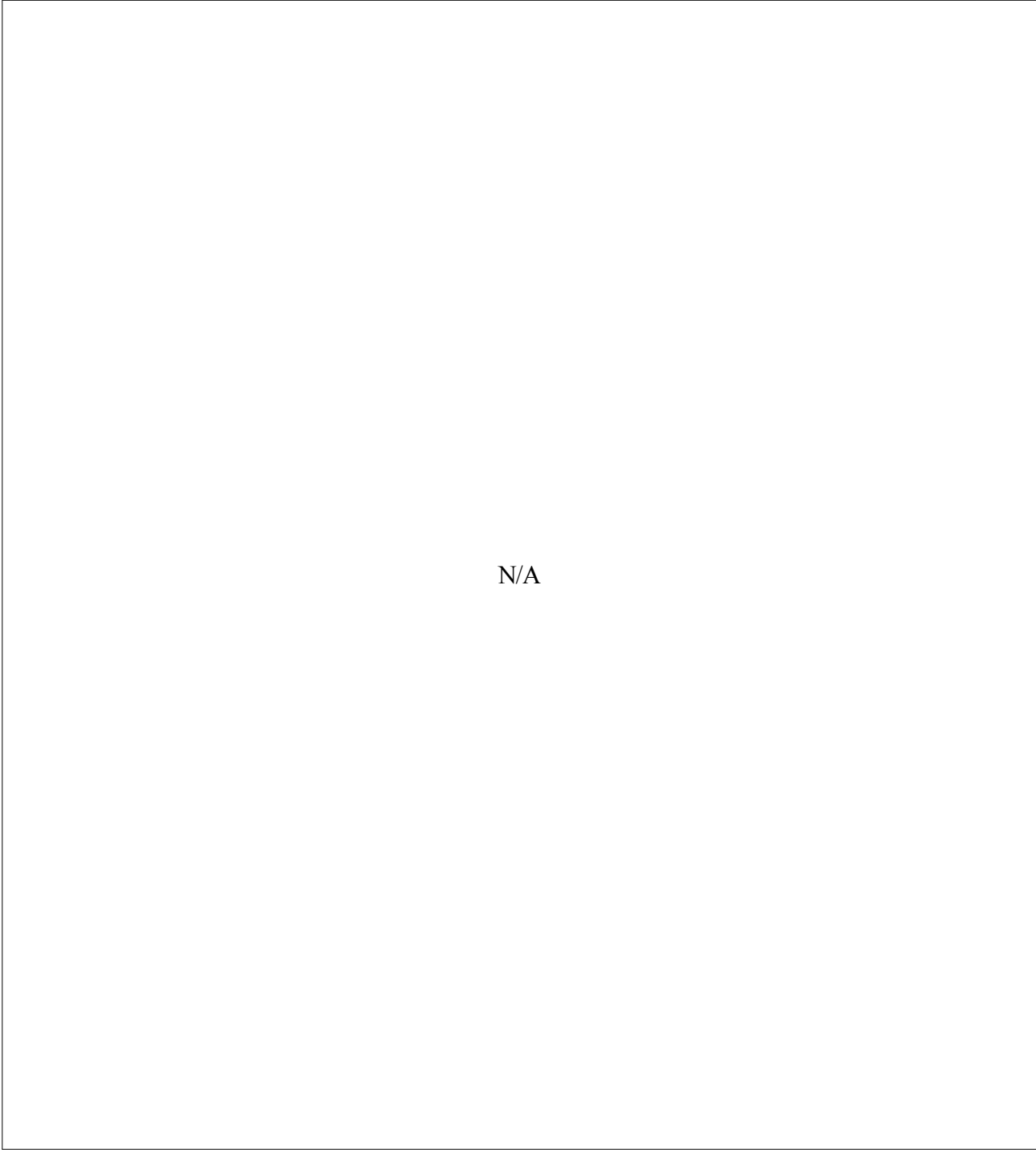

This report shall not be reproduced except in full, without the written approval of KES Co., Ltd.
The test results in the report only apply to the tested sample.

5.2 Radiated Emission Measurements

5.2.1 Test Description

The radiated emissions measurements were performed on the ten-meter open-field test site and 3 m full chamber. The E.U.T was placed on a nonconductive turntable approximately 0.8 meters above the ground plane.

The frequency spectrum from 30 MHz to 1 000 MHz and 1 000 MHz to 6 000 MHz was scanned and maximum emission levels at each frequency recorded.

The system was rotated 360°, and the antenna was varied in the height between 1.0 and 4.0 meters in order to determine the maximum emission levels. This procedure was performed for horizontal and vertical polarization of the receiving antenna.

- above 1 GHz : Antenna height is fixed to 1.0 m

* Below 1 GHz

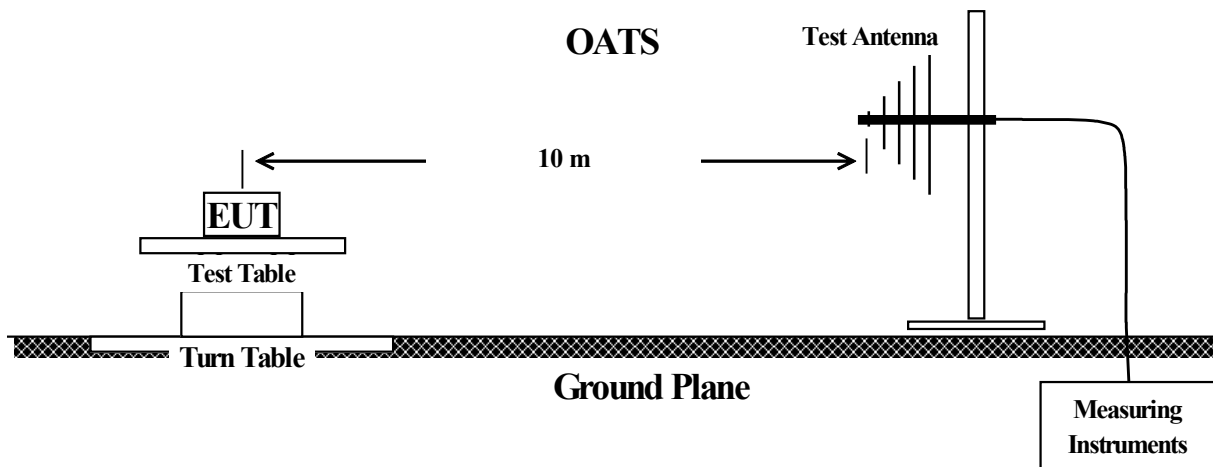

* Above 1 GHz

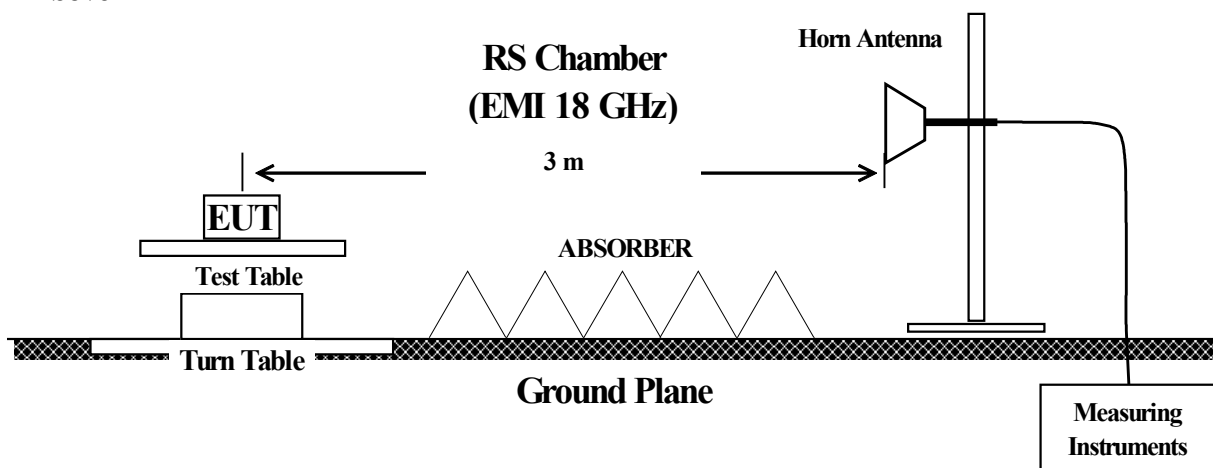

5.2.2 Test Equipments

Description	Manufacturer	Model Number	Serial Number	Cal. Due
EMI TEST Receiver	R & S	ESVS10	826008/014	04. 04. 2015
Trilog-Broadband Antenna	SCHWARZBECK	VULB 9168	9168-385	05. 09. 2015
OATS	KES	-	-	-
Antenna Mast	DAEIL EMC	-	-	-
Turn Table	DAEIL EMC	-	-	-
EMI TEST Receiver	R & S	ESR7	101190	08. 13. 2015
PREAMPLIFIER	8449B	H.P	3008A00538	07. 23. 2015
Double Ridged Horn Antenna	A-H-SYSTEM,INC	SAS-571	781	05. 13. 2015
RS Chamber (EMI 18GHz)	SEMITEC	-	-	-
Antenna Mast	AUDIX	-	-	-
Turn Table	AUDIX	-	-	-

5.2.3 Test Environments

Ambient Temperatures	Relative Humidity
see the data	see the data

5.2.4 Test Limits

Frequency (MHz)	EN 55022	
	Class B @ 10 m (dB μ V/m)	Class A @ 10 m (dB μ V/m)
30 to 230	30.0	40.0
230 to 1 000	37.0	47.0

Frequency (MHz)	EN 55022			
	Class B @ 3 m (dB μ V/m)		Class A @ 3 m (dB μ V/m)	
	PK	AV	PK	AV
1 000 to 3 000	70	50	76	56
3 000 to 6 000	74	54	80	60

5.2.5 Test Procedure

Before final measurements of radiated emission were made on the OATS, the E.U.T was scanned in semi-anechoic chamber in order to determine its emission spectrum signature. The physical arrangement of the test system and associated cabling was varied in order to determine the effect on the E.U.T's emission in amplitude, direction and frequency. This process was repeated during final radiated emission measurements on the OATS range, at each frequency, in order to ensure that maximum emissions amplitudes were attained.

The radiated emission test was performed with E.U.T exercise program loaded, and the emissions were scanned between 30 MHz to 6 000 MHz using the spectrum analyzer. The spectrum analyzer's 6 dB bandwidth was set to 120 kHz(1 MHz), and the analyzer was operated in the CISPR quasi-peak(Peak) detection mode.

Measurements were taken using both HORIZONTAL and VERTICAL antenna polarization, herein referred to as H and V, respectively.

5.2.6 Field Strength Calculation

F.S = Field Strength

M.R = Meter Reading

A.F = Antenna Factor

C.L = Cable Loss

A.G= Amplifier Gain

* Below 1 GHz : $F.S(dB\mu V/m) = M.R(dB\mu V) + [A.F(dB/m) + C.L(dB)]$

* Above 1 GHz : $F.S(dB\mu V/m) = M.R(dB\mu V) + [A.F(dB/m) + C.L(dB)] - A.G(35 dB)$

* Measurement in the presence of high ambient signals

In general, the ambient signals should not exceed the limit. Radiated emanations from the EUT at the point of measurement may, however, be impossible to measure at some frequencies due to ambient noise fields generated by local broadcast services, other manmade devices, and natural sources.

a) Perform measurements at close-in distances and determine the limit L2 corresponding to the close-in distance d2 by applying the following relation:

$$L2 = L1 (d1/d2)$$

where L1 is the specified limit in microvolts per metre ($\mu V/m$) at the distance d1.
Determine the possible environmental and compliance test conditions stipulated in Clause 8 using L2 as the new limit for distance d2.

b) In the frequency bands where the ambient noise values of Clause 8 are exceeded (measured values higher than 6 dB below the limit), the disturbance values of the EUT may be interpolated from the adjacent disturbance values. The interpolated value shall lie on the curve describing a continuous function of the disturbance values adjacent to the ambient noise.

5.2.7 Test Results

According to the data in section 5.2.8, the E.U.T complied with the EN 55022/CISPR22 standards.

5.2.8 Test Data

* Below 1 GHz

Temperature: 2.0 °C Humidity: 28.0 % R.H. Test Date: 02. 13. 2015 Tested by: Tae Yeon, Kim

Frequency (MHz)	Amplitude (dB μ V/m)	Antenna		Correction Factor		Corrected Amplitude (dB μ V/m)	Applicable Limit (dB μ V/m)	Margin (dB)
		Polar. (H/V)	Height (m)	Ant. (dB)	Cable (dB)			
56.770	13.900	V	1.000	13.290	1.740	28.930	40.000	11.070
259.880	26.100	H	4.000	12.080	3.970	42.150	47.000	4.850
297.000	21.500	H	3.800	13.300	4.350	39.150	47.000	7.850
371.230	18.400	H	2.220	14.950	4.920	38.270	47.000	8.730
371.250	20.400	V	1.000	14.950	4.920	40.270	47.000	6.730
400.000	19.100	V	1.000	15.580	5.140	39.820	47.000	7.180
400.020	20.300	H	2.420	15.580	5.140	41.020	47.000	5.980
525.020	20.000	H	2.060	18.220	6.070	44.290	47.000	2.710

*** Above 1 GHz**

Temperature: 24.1 °C Humidity: 36.2 % R.H. Test Date: 02. 13. 2015 Tested by: Tae Yeon, Kim

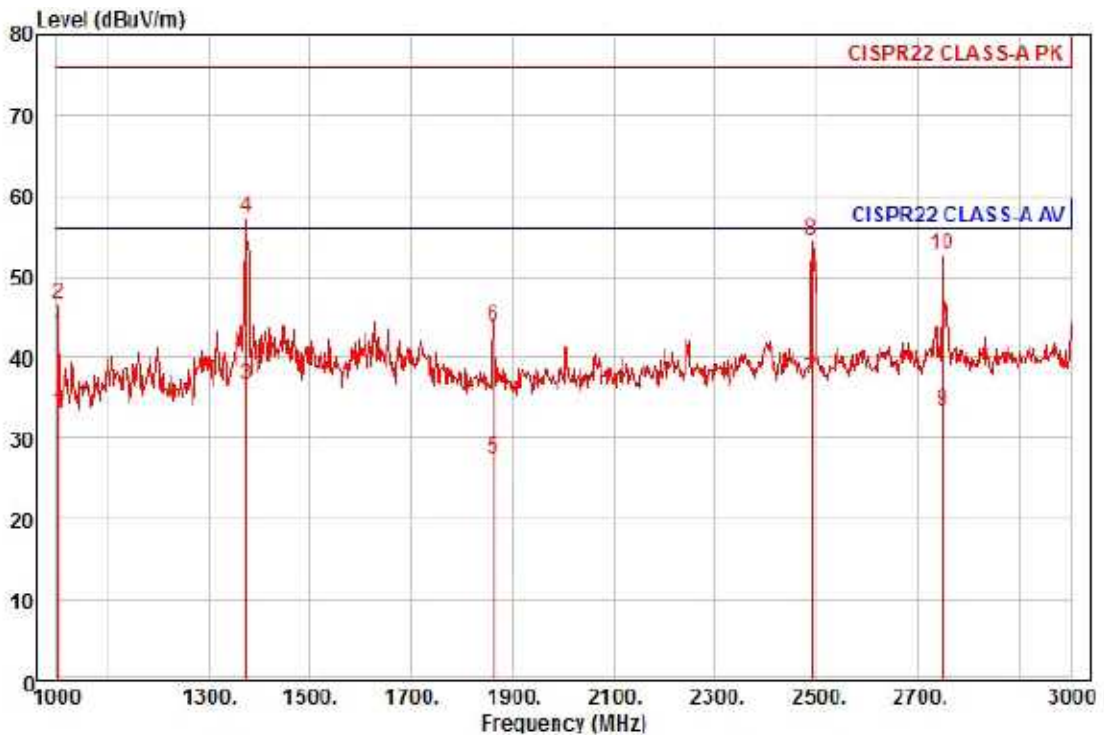

Site : chamber
Condition: CISPR22 CLASS-A PK 3m HORN ANT (2014.03.10) horizontal
: RBW:1000.000kHz VBW:1000.000kHz SWT:Auto
Project : network camera
EUT : SNV-L6083RP
Mode : CE
Memo : (1 ~ 3) GHz

	Read Freq	Ant Level	Ant Factor	Cable Loss	Preamp Factor	TPos	Limit Line	Over Limit	Pol/Phase	Remark
	MHz	dBuV	dB/m	dB	dB	deg	dBuV/m	dB		
1	1002.00	40.81	23.00	5.44	36.20	232	56.00	-22.95	horizontal	Average
2	1002.00	54.36	23.00	5.44	36.20	232	76.00	-29.40	horizontal	Peak
3	1374.00	41.30	24.51	6.35	35.58	287	56.00	-19.42	horizontal	Average
4 pp	1374.00	62.04	24.51	6.35	35.58	287	76.00	-18.68	horizontal	Peak
5	1864.00	27.27	27.33	7.53	34.76	331	56.00	-28.63	horizontal	Average
6	1864.00	43.79	27.33	7.53	34.76	331	76.00	-32.11	horizontal	Peak
7 av	2490.00	33.29	29.24	8.89	34.19	210	56.00	-18.77	horizontal	Average
8	2490.00	50.52	29.24	8.89	34.19	210	76.00	-21.54	horizontal	Peak
9	2748.00	28.22	29.75	9.43	34.01	184	56.00	-22.61	horizontal	Average
10	2748.00	47.54	29.75	9.43	34.01	184	76.00	-23.29	horizontal	Peak

This report shall not be reproduced except in full, without the written approval of KES Co., Ltd.
The test results in the report only apply to the tested sample.

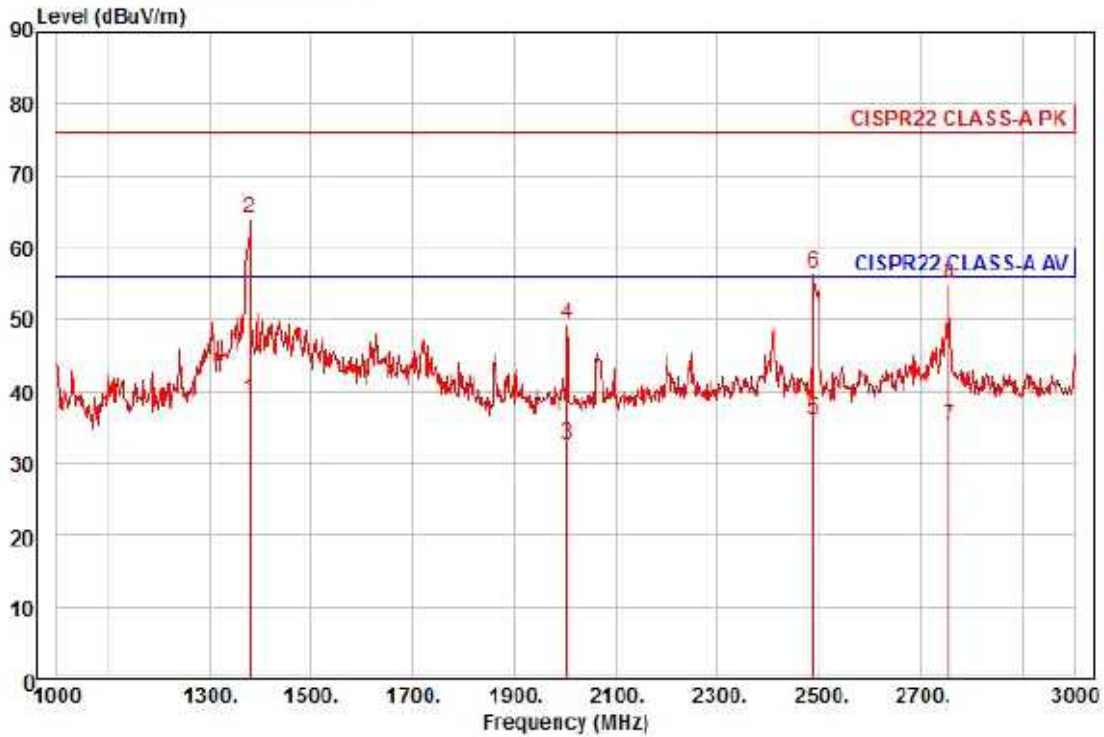

Site : chamber
 Condition: CISPR22 CLASS-A PK 3m HORN ANT (2014.03.10) vertical
 : RBW:1000.000kHz VBW:1000.000kHz SWT:Auto
 Project : network camera
 EUT : SNV-L6083RP
 Mode : CE
 Memo : (1 ~ 3) GHz

		Read	Ant	Cable	Preamp	TPos	Limit	Over		
	Freq	Level	Factor	Loss	Factor	deg	Line	Limit	Pol/Phase	Remark
	MHz	dBuV	dB/m	dB	dB	deg	dBuV/m	dB		
1	av	1380.00	43.49	24.53	6.36	35.57	88	56.00	-17.19	vertical Average
2	pp	1380.00	68.66	24.53	6.36	35.57	88	76.00	-12.02	vertical Peak
3		2004.00	31.01	28.20	7.87	34.53	265	56.00	-23.45	vertical Average
4		2004.00	47.87	28.20	7.87	34.53	265	76.00	-26.59	vertical Peak
5		2488.00	32.24	29.23	8.88	34.19	139	56.00	-19.84	vertical Average
6		2488.00	52.47	29.23	8.88	34.19	139	76.00	-19.61	vertical Peak
7		2756.00	29.74	29.77	9.45	34.01	123	56.00	-21.05	vertical Average
8		2756.00	49.72	29.77	9.45	34.01	123	76.00	-21.07	vertical Peak

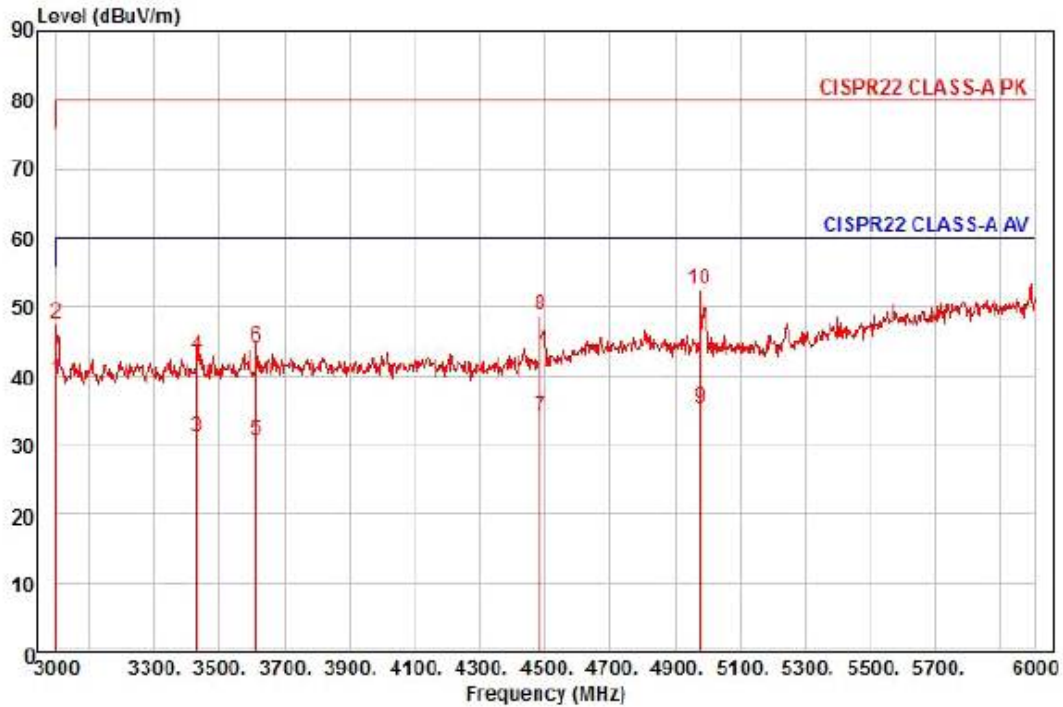

Site : chamber
 Condition: CISPR22 CLASS-A PK 3m HORN ANT (2014.03.10) horizontal
 : RBW:1000.000kHz VBW:1000.000kHz SWT:Auto
 Project : network camera
 EUT : SNV-L6083RP
 Mode : CE
 Memo : (3 ~ 6) GHz

	Read	Ant	Cable	Preamp	TPos	Limit	Over		
Freq	Level	Factor	Loss	Factor		Line	Limit	Pol/Phase	Remark
MHz	dBuV	dB/m	dB	dB	deg	dBuV/m	dB		
1 pp	3000.00	32.99	30.25	9.96	33.84	115	56.00	-16.64	horizontal Average
2	3000.00	41.17	30.25	9.96	33.84	115	76.00	-28.46	horizontal Peak
3	3432.00	24.35	30.41	10.63	34.33	345	60.00	-28.94	horizontal Average
4	3432.00	36.15	30.41	10.63	34.33	345	80.00	-37.14	horizontal Peak
5	3615.00	23.52	30.77	10.92	34.53	283	60.00	-29.32	horizontal Average
6	3615.00	37.04	30.77	10.92	34.53	283	80.00	-35.80	horizontal Peak
7	4485.00	23.94	32.03	12.32	34.12	339	60.00	-25.83	horizontal Average
8	4485.00	38.52	32.03	12.32	34.12	339	80.00	-31.25	horizontal Peak
9	4977.00	21.84	33.66	13.13	33.25	302	60.00	-24.62	horizontal Average
10 pk	4977.00	39.04	33.66	13.13	33.25	302	80.00	-27.42	horizontal Peak

This report shall not be reproduced except in full, without the written approval of KES Co., Ltd.
 The test results in the report only apply to the tested sample.

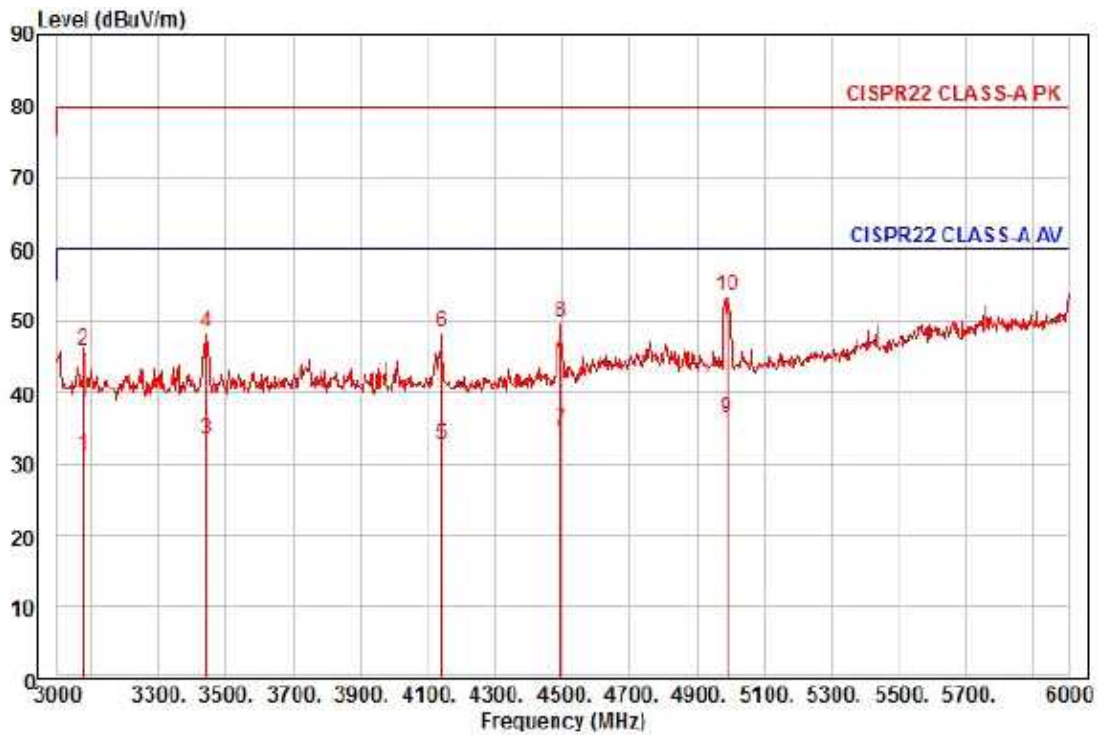

Site : chamber
 Condition: CISPR22 CLASS-A PK 3m HORN ANT (2014.03.10) vertical
 : RBW:1000.000kHz VBW:1000.000kHz SWT:Auto
 Project : network camera
 EUT : SNV-L6083RP
 Mode : CE
 Memo : (3 ~ 6) GHz

	Freq	Read Level	Ant Factor	Cable Loss	Preamp Factor	TPos	Limit Line	Over Limit	Pol/Phase	Remark
	MHz	dBuV	dB/m	dB	dB	deg	dBuV/m	dB		
1	3078.00	24.77	30.28	10.08	33.93	343	60.00	-28.80	vertical	Average
2	3078.00	39.39	30.28	10.08	33.93	343	80.00	-34.18	vertical	Peak
3	3441.00	26.56	30.41	10.65	34.34	293	60.00	-26.72	vertical	Average
4	3441.00	41.54	30.41	10.65	34.34	293	80.00	-31.74	vertical	Peak
5	4140.00	23.65	31.95	11.75	34.72	109	60.00	-27.37	vertical	Average
6	4140.00	39.37	31.95	11.75	34.72	109	80.00	-31.65	vertical	Peak
7	4497.00	24.21	32.03	12.34	34.10	24	60.00	-25.52	vertical	Average
8	4497.00	39.45	32.03	12.34	34.10	24	80.00	-30.28	vertical	Peak
9 pp	4989.00	22.65	33.70	13.15	33.23	159	60.00	-23.73	vertical	Average
10 pk	4989.00	39.94	33.70	13.15	33.23	159	80.00	-26.44	vertical	Peak

5.3 Harmonics / Voltage Fluctuations Measurements

5.3.1 Test Description

Harmonics of the fundamental current were measured up to 2 kHz using a universal power analyzer. The measurements were carried out under steady conditions and using averaging.

Before making measurements the class of the E.U.T has been evaluated, it is necessary for the E.U.T to decide which class the E.U.T fulfills into; A, B, C or D

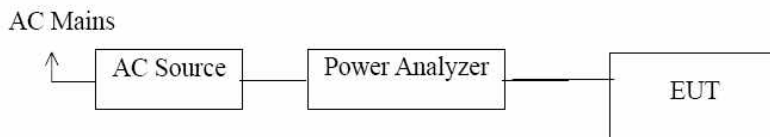

5.3.2 Test Equipments

Description	Manufacturer	Model Number	Serial Number	Cal. Due
AC Source	EM test	ACS 500 N	V1024106760	08. 13. 2015
Digital Power Analyzer	EM test	DPA 500 N	V1024106759	08. 13. 2015

5.3.3 Test Environments

Ambient Temperatures : see the data

Relative Humidity : see the data

5.3.4 Test Procedures

The E.U.T was installed and placed on a non-conductive table and was connected to the AC power source, 230 V (ac), 50 Hz via the measuring equipment with its attached AC power cord. All other equipment or peripherals included in the test, and having a separate power supply, are connected to the outlet, supplying 230 V (ac), 50 Hz. A typical configuration is defined in the specification ANSI 63.4 or CISPR22. This ensures the repeatability of the test.

The E.U.T is set in operation and was monitored for measurements with the software, supplied by test equipment manufacturer. An EMC test program provided by client was used to exercise the E.U.T.



5.3.5 Test Results

N/A : This device operate by POE power. Test is not applicable.

5.3.6 Test Data - Harmonic

Temperature: °C Humidity: % R.H. Test Date: Tested by:

<i>Average harmonic current results</i>				
Hn	I _{eff} [A]	% of Limit	Limit [A]	Result
1	N/A	N/A	N/A	N/A
2				
3				
4				
5				
6				
7				
8				
9				
10				
11				
12				
13				
14				
15				
16				
17				
18				
19				
20				
21				
22				
23				
24				
25				
26				
27				
28				
29				
30				
31				
32				
33				
34				
35				
36				
37				
38				
39				
40				

This report shall not be reproduced except in full, without the written approval of KES Co., Ltd.
The test results in the report only apply to the tested sample.



Test Data - Harmonics (continued)

<i>Maximum harmonic voltage results</i>				
Hn	I _{eff} [A]	U _{eff} [%]	Limit [%]	Result
1	N/A	N/A	N/A	N/A
2				
3				
4				
5				
6				
7				
8				
9				
10				
11				
12				
13				
14				
15				
16				
17				
18				
19				
20				
21				
22				
23				
24				
25				
26				
27				
28				
29				
30				
31				
32				
33				
34				
35				
36				
37				
38				
39				
40				

This report shall not be reproduced except in full, without the written approval of KES Co., Ltd.
The test results in the report only apply to the tested sample.

5.3.7 Test Data - Voltage Fluctuations

Maximum Flicker results

	E.U.T values	Limit	Result
Pst	N/A	N/A	N/A
Plt			
dc [%]			
dmax [%]			
dt [s]			

5.4 Electrostatic Discharge Immunity

5.4.1 Test Description

The E.U.T and all local support equipment were placed on non-metallic support 0.8 m above a reference ground plane (RGP) and was put into operation according to the specified operating mode.

5.4.2 Test Equipments

Description	Manufacturer	Model Number	Serial Number	Cal. Due
ESD SIMULATOR	Noise Ken	ESS-2000	ESS05X4620	06.30.2015

5.4.3 Test Environment

Ambient Temperatures :	15 °C ~ 35 °C
Relative Humidity :	25 % R.H. ~ 75 % R.H.
Atmospheric Pressure :	86.0 kPa ~ 106.0 kPa

5.4.4 Test Levels

Discharge Impedance :	330 Ω ± 10 % / 150 pF ± 10 %
Type of Discharge :	Direct - Air Discharge(± 2 / ± 4 / ± 8 kV), Contact Discharge(± 2 / ± 4 / ± 6 kV) Indirect - HCP Discharge(± 4 / ± 6 kV), VCP Discharge(± 4 / ± 6 kV)
Polarity of Output Voltage :	Positive and Negative
Discharge Repetition Rate :	1/sec
Number of Discharges :	more than 10 times
Performance Criteria :	B

5.4.5 Test Procedure

Test programs and software were chosen so as to exercise all normal modes of operation of the E.U.T. The use of special exercising software is encouraged, but permitted only where it can be shown that the E.U.T is being comprehensively exercised.

The test was conducted in the following order: Air Discharge, Direct Contact Discharge, Indirect Contact Horizontal Coupling Plane (HCP) Discharge, and Indirect Contact Vertical Coupling Plane (VCP) Discharge. The electrostatic discharge test levels were set and discharges for the different test modes were set appropriately. The electrostatic discharge is applied to the conductive surface of the E.U.T, and along all seams and control surfaces on the E.U.T. When a discharge occurs and an error is caused, the type of error, discharge level and location is recorded.



5.4.6 Test Results

According to the data in section 5.4.7, the E.U.T complied with the EN61000-4-2 standards, and detailed test results are found in the following test data.

5.4.7 Test Data

Temperature: 24.5 °C Humidity: 35.1 % R.H. Test Date: 02. 12. 2015 Tested by: Tae Yeon, Kim

Indirect Discharge

No.	Test Point	Discharge Method	Performance		Remarks
			Test level	Results	
1	HCP Contact	Contact Discharge	± (2,4,6)kV	complied	-
2	VCP Contact	Contact Discharge	± (2,4,6)kV	complied	-

Direct Discharge

No.	Test Point	Discharge Method	Performance		Remarks
			Test level	Results	
1	Side	Contact Discharge	B	A	-
2	Bottom	Contact Discharge	B	A	-

10 times Indirect discharge test for each polarity.

5.5 Radio-frequency electromagnetic field Amplitude modulated Immunity

5.5.1 Test Description

The E.U.T and all local support equipment were placed on a non-metallic support 0.8 m above a reference ground plane (RGP) and was put into operation according to the specified operating mode.

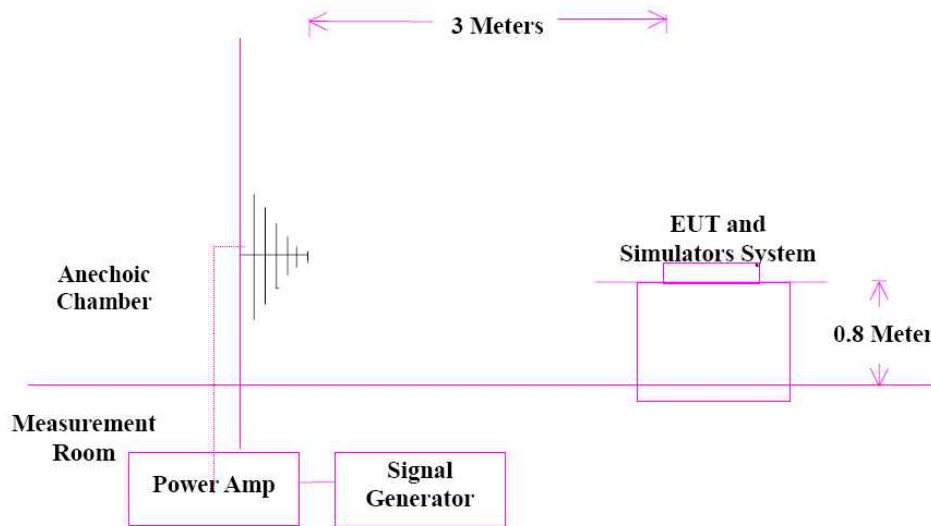

5.5.2 Test Equipments

Description	Manufacturer	Model Number	Serial Number	Cal. Due
Average Power Sensor	Agilent	E9301A	MY41498011	08.13.2015
Average Power Sensor	Agilent	E9301A	-	08.13.2015
Signal Generator	HP	ESG-3000A	US37040210	08.13.2015
Power Meter	Agilent	E4419B	MY45101506	08.13.2015
Power Amplifier	Infinitech	ITA0300-200	-	08.13.2015
Power Amplifier	Infinitech	ITA0750-200	-	08.13.2015
Power Amplifier	Infinitech	ITA1500-100	-	08.13.2015
Power Amplifier	Infinitech	ITA2500-100	-	08.13.2015
Stacked Log.-Per. Antenna	Schwarzbeck	STLP 9128 D	9128D038	-
RS Chamber(EMI 18GHz)	SEMITEC	-	-	-

5.5.3 Test Environments

Ambient Temperatures :	15 °C ~ 35 °C
Relative Humidity :	25 % R.H. ~ 75 % R.H.
Atmospheric Pressure :	86.0 kPa ~ 106.0 kPa

5.5.4 Test Levels

Frequency Range :	80 MHz to 2 700 MHz
Field Strength :	10 V/m(3 V/m, 1 V/m)
Modulation :	80 % Amplitude Modulation (1 kHz) Pulse Modulation (1 Hz (0.5 s ON: 0.5 s OFF))
Distance of ANT-E.U.T :	3 meters
Antenna Polarity :	Horizontal and Vertical
Frequency Step :	1 %
Performance Criteria :	A

5.5.5 Test Procedures

The E.U.T is set into operation and was monitored for variations in performance. The test signal start frequency (80 MHz) and stop frequency (2 700 MHz) were set, including the field strength at 10 V/m(3 V/m, 1 V/m), 80 % modulated through immunity test software. The software maintains the necessary field strength through the frequency range, with the transmitting antenna horizontally polarized. If an error is detected, the field is reduced until the error is not repeatable, the field is then manually increased until the error begins to occur. This threshold level, the frequency and the error created are noted before continuing. The test is then repeated with vertical polarization, using the same test configuration for all four sides.

5.5.6 Test Results

According to the data in section 5.5.7, the E.U.T complied with the EN61000-4-3 standards, and detailed test results are found in the following test data.

5.5.7 Test Data

Temperature: 22.0 °C Humidity: 37.6 % R.H. Test Date: 02. 11. 2015 Tested by: Tae Yeon, Kim

No.	Test Point	Performance Results		Remarks
		Horizontal	Vertical	
1	Front	complied	complied	-
2	Rear	complied	complied	-
3	Right Side	complied	complied	-
4	Left Side	complied	complied	-

5.6 Fast Transient Immunity

5.6.1 Test Description

The E.U.T and all local support equipment were placed a non-metallic support 0.8 m above a reference ground plane (RGP) and was put into operation according to the specified operating mode. If the E.U.T has a non-detachable supply cable more than 1 m long, the excess length of this cable was gathered into a flat coil with a 0.4 m diameter and situated at a distance of 0.1 m above the RGP.

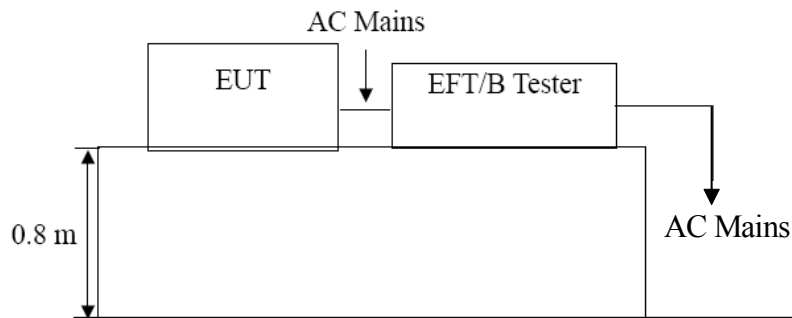

5.6.2 Test Equipments

Description	Manufacturer	Model Number	Serial Number	Cal. Due
Ultra Compact Simulator	EM TEST	UCS 500 N5	V0936105120	08. 13. 2015
Capacitive Coupling Clamp	EM TEST	HFK	070925	08. 14. 2015
MotorVariac	EM TEST	MV2616	V0936105123	08. 13. 2015

5.6.3 Test Environments

Ambient Temperatures :	15 °C ~ 35 °C
Relative Humidity :	25 % R.H. ~ 75 % R.H.
Atmospheric Pressure :	86.0 kPa ~ 106.0 kPa

5.6.4 Test Levels

Open Circuit Output Test Voltage :	<input type="checkbox"/> Power Supply AC; ± 2 kV <input type="checkbox"/> Power Supply DC; ± 1 kV <input checked="" type="checkbox"/> I/O Signal, Data and Control ports; ± 1 kV
Repetition Frequency of the Impulses :	100 kHz
Polarity :	Positive and Negative
Rise Time of One Pulse :	5 ns ± 30 %
Impulse Duration :	50 ns ± 30 %
Burst Duration :	15 ms ± 20 %
Burst Period :	300 ms ± 20 %
Performance Criteria :	B

5.6.5 Test Procedure

The E.U.T was connected to the test equipment, and monitored for performance. The test level was set and the test signal was applied for 200 seconds. A test signal of ± 1 kV, and ± 2 kV was Coupled to Line and Ground, Neutral and Ground, Line plus Neutral and Ground, and Protective Earth and Ground. When an error occurs, the test level is reduced until the error recovers and then increased until the threshold level is reached. This threshold and the error conditions were noted. This procedure was then repeated for the other coupling modes.

5.6.6 Test Results

According to the data in section 5.6.7, the E.U.T complied with the EN61000-4-4 standards, and detailed test results are found in the following test data.

5.6.7 Test Data

Temperature: 20.2 °C Humidity: 36.1 % R.H. Test Date: 02.10.2015 Tested by: Tae Yeon, Kim

On AC Power Supply

No.	Test Point	Test Level	Performance Results		Remarks
			+Burst	-Burst	
1	-	± 2 kV	-	-	
2	-	± 2 kV	-	-	
3	-	± 2 kV	-	-	

On DC Power Supply

No.	Test Point	Test Level	Performance Results		Remarks
			+Burst	-Burst	
1	-	± 1 kV	-	-	-
2	-	± 1 kV	-	-	-
3	-	± 1 kV	-	-	-

On I/O Signal, Data and Control ports

No.	Test Point	Test Level	Performance Results		Remarks
			+Burst	-Burst	
1	RJ-45(POE)	± 1 kV	complied	complied	-

5.7 Surge Immunity

5.7.1 Test Description

The E.U.T and all local support equipment was placed on a non-metallic support 0.8 m above a reference ground plane (RGP) and was put into operation according to the specified operating mode.

5.7.2 Test Equipments

Description	Manufacturer	Model Number	Serial Number	Cal. Due
Ultra Compact Simulator	EM TEST	UCS 500 N5	V0936105120	08. 14. 2015
MotorVariac	EM TEST	MV2616	V0936105123	08. 13. 2015
CDN	EM TEST	CNV 504N	V0936105121	-

5.7.3 Test Environments

Ambient Temperatures :	15 °C ~ 35 °C
Relative Humidity :	25 % R.H. ~ 75 % R.H.
Atmospheric Pressure :	86.0 kPa ~ 106.0 kPa

5.7.4 Test Levels

Open Circuit Test Voltage :	<input type="checkbox"/> AC Power; ± 1 kV line-to-line, <input type="checkbox"/> AC Power, ± 2 kV line-to-ground <input type="checkbox"/> DC Power; ± 0,5 kV line-to-ground <input checked="" type="checkbox"/> Data and Control Line; ± 1 kV line-to-ground
Open Circuit Voltage Waveform :	1.2/50 microsecond
Short Circuit Current Waveform :	8/20 microsecond
Number of Tests :	5 positive and 5 negative
Repetition Rate :	1/min
Performance Criteria :	B

5.7.5 Test Procedure

The surges have to be applied line to line and line(s) and ground. In case of testing line to ground the test voltage has to be applied successively between each of the lines and ground, if there is no other specification. All lower levels including the selected test level must be satisfied. For testing the secondary protection the output voltage of the generator must be increased up to the worst case voltage break down level of the primary protection.

5.7.6 Test Results

According to the data in section 5.7.7, the E.U.T complied with the EN61000-4-5 standards, and detailed test results are found in the following test data.

5.7.7 Test Data

Temperature: 21.7 °C Humidity: 38.4 % R.H. Test Date: 02.16.2015 Tested by: Tae Yeon, Kim

On AC Power Supply

No.	Test Point	Test Level	Performance Results		Remarks
			+Surge	-Surge	
1	-	± (0,5, 1) kV	-	-	

On I/O Signal, Data and Control ports

No.	Test Point	Test Level	Performance Results		Remarks
			+Surge	-Surge	
1	RJ-45(POE)	± (0,5, 1) kV	complied	complied	

5.8 Radio-frequency continuous conducted Immunity

5.8.1 Test Descriptions

The E.U.T and all local support equipment were placed on a non-metallic support 0.1 m above a reference ground plane (RGP) and was put into operation according to the specified operating mode.

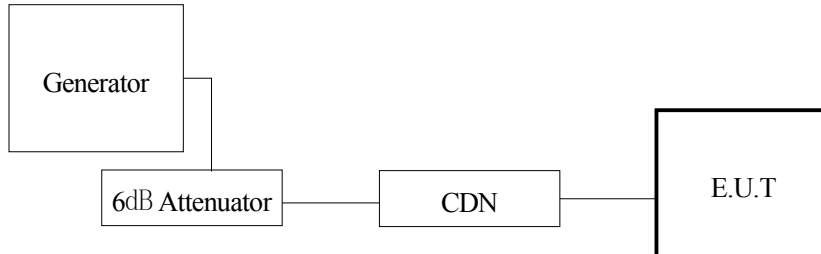

5.8.2 Test Equipments

Description	Manufacturer	Model Number	Serial Number	Cal. Due
Continuous Wave Simulator	EM TEST	CWS 500N1	V0936105119	08. 14. 2015
6dB Attenuator	EM TEST	ATT6	1208-34	08. 13. 2015
CDN	EM TEST	CDN-M2/M3N	0909-06	08. 13. 2015
EM Injection Clamp	EM TEST	EM 101	36152	05. 14. 2015

5.8.3 Test Environments

Ambient Temperatures :	15 °C ~ 35 °C
Relative Humidity :	25 % R.H. ~ 75 % R.H.
Atmospheric Pressure :	86.0 kPa ~ 106.0 kPa

5.8.4 Test Levels

Frequency Range :	150 kHz to 100 MHz
Voltage Level :	10 V(3 V, 1 V)
Modulation :	80 % Amplitude Modulation (1 kHz) Pulse Modulation (1 Hz (0.5 s ON: 0.5 s OFF))
Frequency Step :	1 %
Performance Criteria :	A

5.8.5 Test Procedure

The test was performed with the test generator connected to each of the coupling and decoupling devices in turn while the other non-excited RF-input ports of the coupling devices are terminated by a 50 Ω load resistor. The frequency range is swept from 150 kHz to 100 MHz, using the signal levels established during the setting process, and with the disturbance signal 80 % amplitude modulated with a 1kHz sine wave, pausing to adjust the RF-signal level or to switch coupling device as necessary.

5.8.6 Test Results

According to the data in section 5.8.7, the E.U.T complied with the EN61000-4-6 standards, and detailed test results are found in the following test data.

5.8.7 Test Data

Temperature: 20.2 °C Humidity: 36.1 % R.H. Test Date: 02. 10. 2015 Tested by: Tae Yeon, Kim

On AC Power Supply

No.	Test Point	Performance		Remarks
		Coupling method	Results	
1	-	CDN	-	

On DC Power Supply

No.	Test Point	Performance		Remarks
		Coupling method	Results	
1	-	CDN	-	-

On I/O Signal, Data and Control ports

No.	Test Point	Performance		Remarks
		Coupling method	Results	
1	RJ-45(POE)	EM Clamp	complied	-

5.9 Voltage Dips and Voltage Interruptions Immunity Measurements

5.9.1 Test Descriptions

The E.U.T and all local support equipment was placed on a non-metallic support 0.8 m above a reference ground plane (RGP) and was put into operation according to the specified operating mode.

5.9.2 Test Equipments

Description	Manufacturer	Model Number	Serial Number	Cal. Due
Ultra Compact Simulator	EM TEST	UCS 500 N5	V0936105120	08.13.2015
MotorVariac	EM TEST	MV2616	V0936105123	08.13.2015

5.9.3 Test Environments

Ambient Temperatures :	15 °C ~ 35 °C
Relative Humidity :	25 % R.H. ~ 75 % R.H.
Atmospheric Pressure :	86.0 kPa ~ 106.0 kPa

5.9.4 Test Levels

Overshoot/Undershoot of Actual Voltage :	Less than ± 5 % of the change in voltage
Voltage Rise and Fall Time :	Between 1 and 5 microseconds
Test Voltage / Test Frequency :	230 V (ac) / 50 Hz
Frequency Deviation of Test Voltage :	Less than ± 2 % of rated frequency
Number of Tests :	3 times
Test Intervals :	10 sec
Performance Criteria :	B for Voltage Dips C for Voltage Short Interruptions A for Voltage Variation

5.9.5 Test Procedure

For each test any degradation of performance were recorded. The monitoring equipment should be capable of displaying the status of the operational mode of the E.U.T during and after the tests. After each group of tests a full functional check were performed.



5.9.6 Test Results

N/A : This device operate by POE power. Test is not applicable.

5.9.7 Test Data

Temperature: °C Humidity: % R.H. Test Date: Tested by:

Voltage Dips(AC Power Supply)

No.	Depth	Duration	Results	Remarks
1	20 %	250T	-	-
2	30 %	25T		
3	60 %	10T	-	-
4	100 %	250T	-	-

Voltage variations(AC Power Supply)

No.	Test Level		Results	Remarks
1	Unom + 10 %	253 V (ac)	-	-
2	Unom - 15 %	195.5 V (ac)	-	-

This report shall not be reproduced except in full, without the written approval of KES Co., Ltd.
The test results in the report only apply to the tested sample.

6. Test Setup Photographs

6.1 Conducted Emission

- AC Main

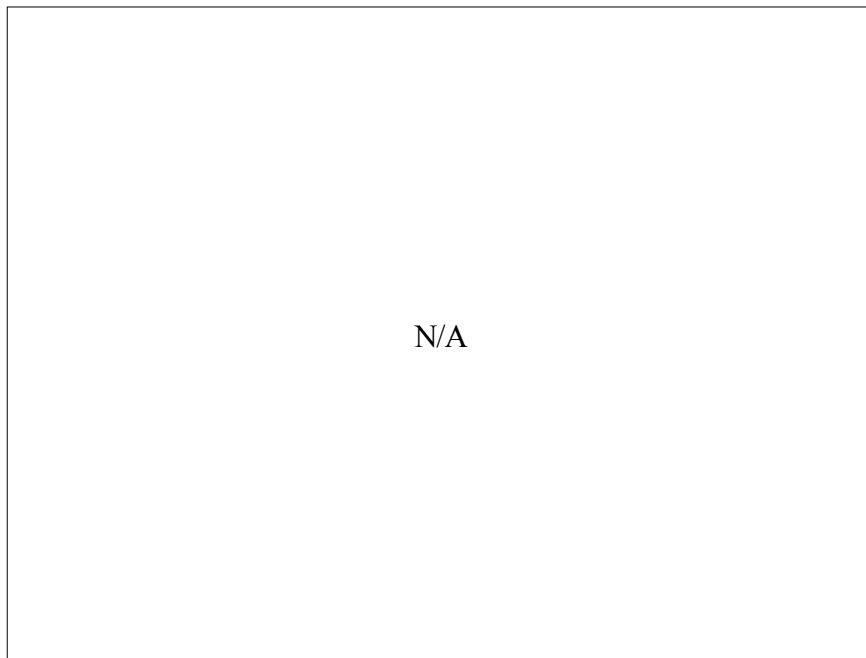
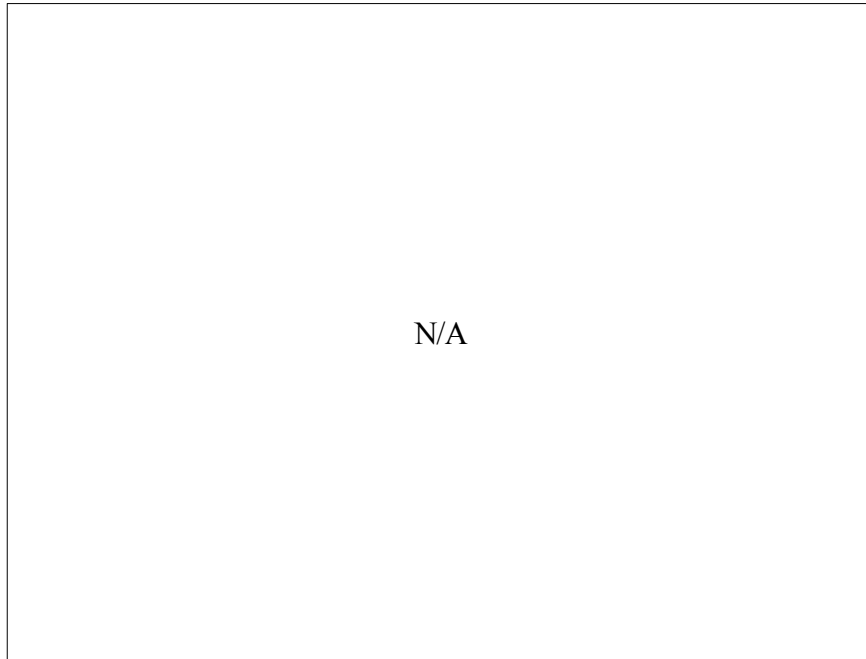

- **Telecommunication Emission**

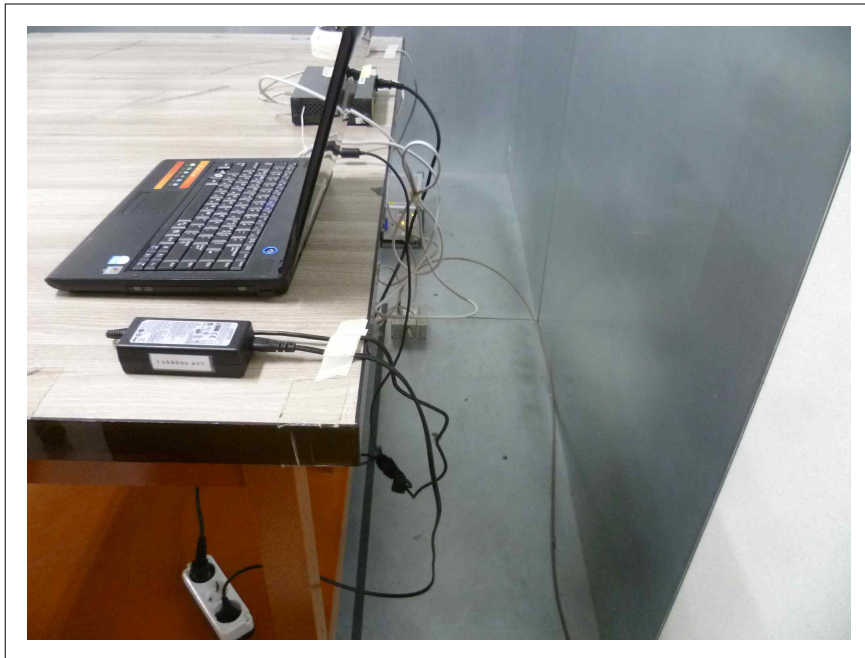
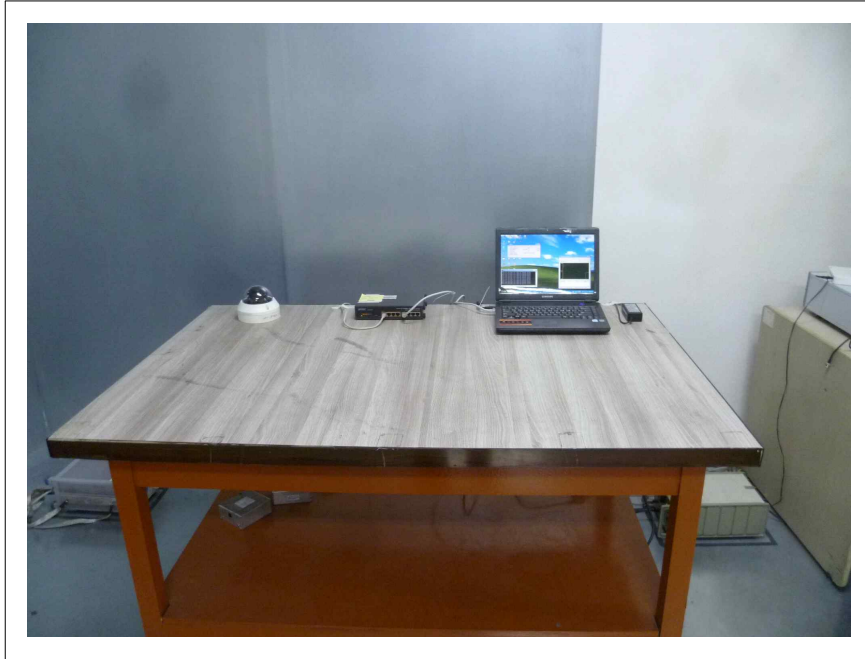

This report shall not be reproduced except in full, without the written approval of KES Co., Ltd.
The test results in the report only apply to the tested sample.

6.2 Radiated Emission

* Below 1 GHz

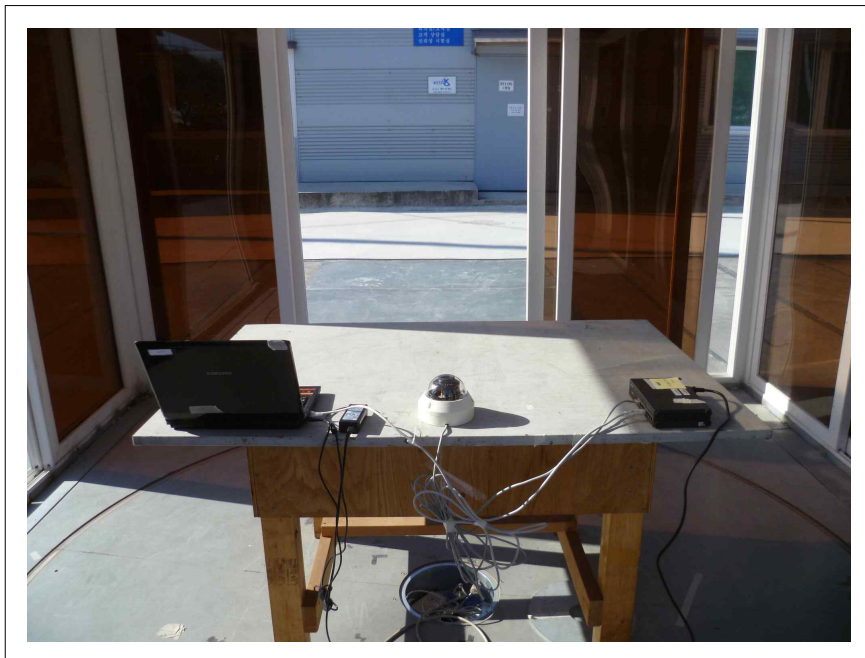
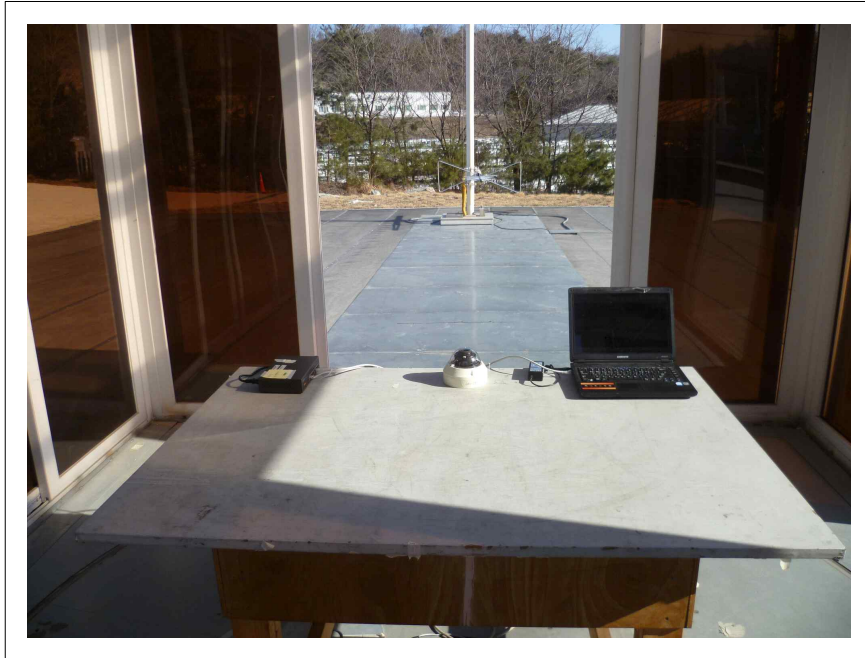

This report shall not be reproduced except in full, without the written approval of KES Co., Ltd.
The test results in the report only apply to the tested sample.

* Above 1 GHz

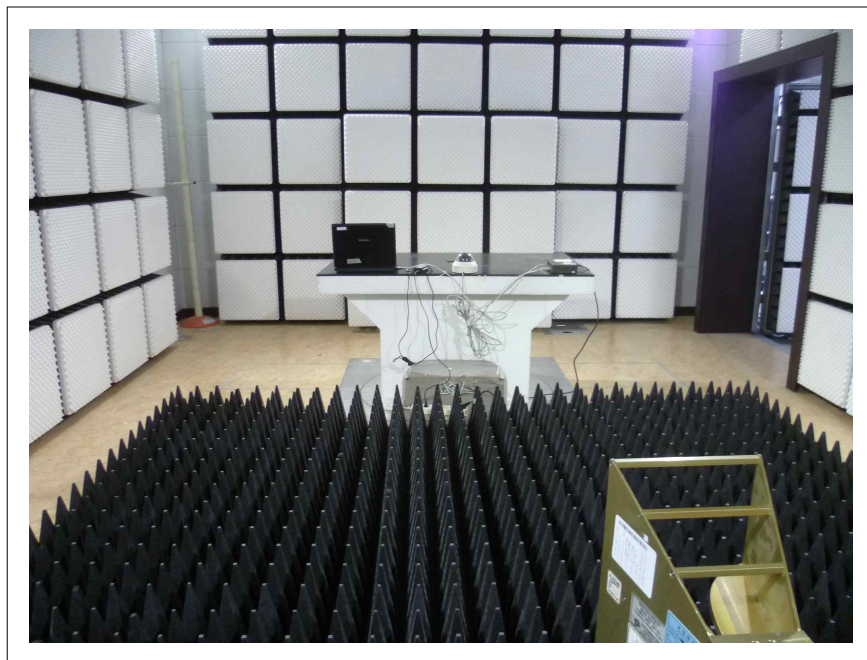
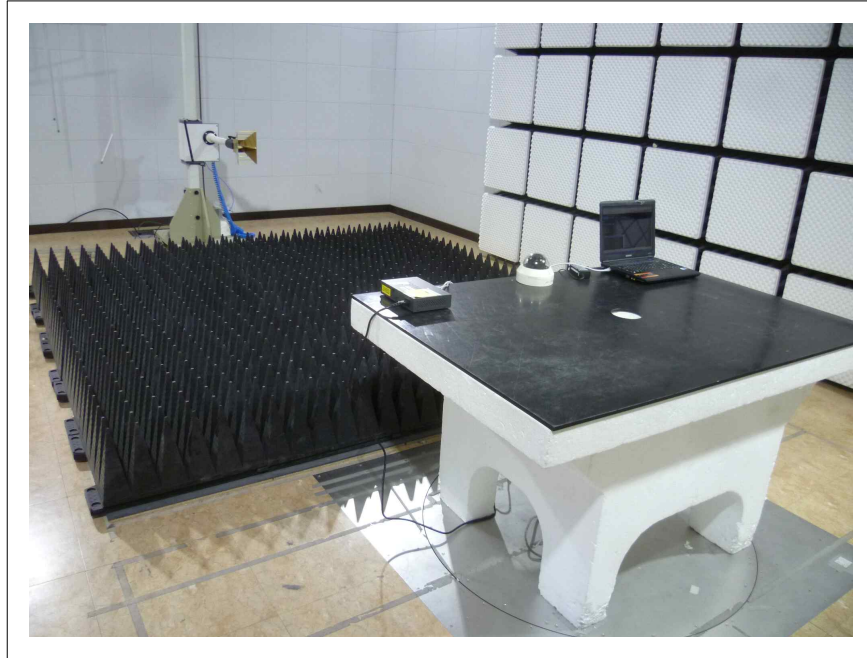

This report shall not be reproduced except in full, without the written approval of KES Co., Ltd.
The test results in the report only apply to the tested sample.

6.3 Harmonics / Voltage Fluctuations

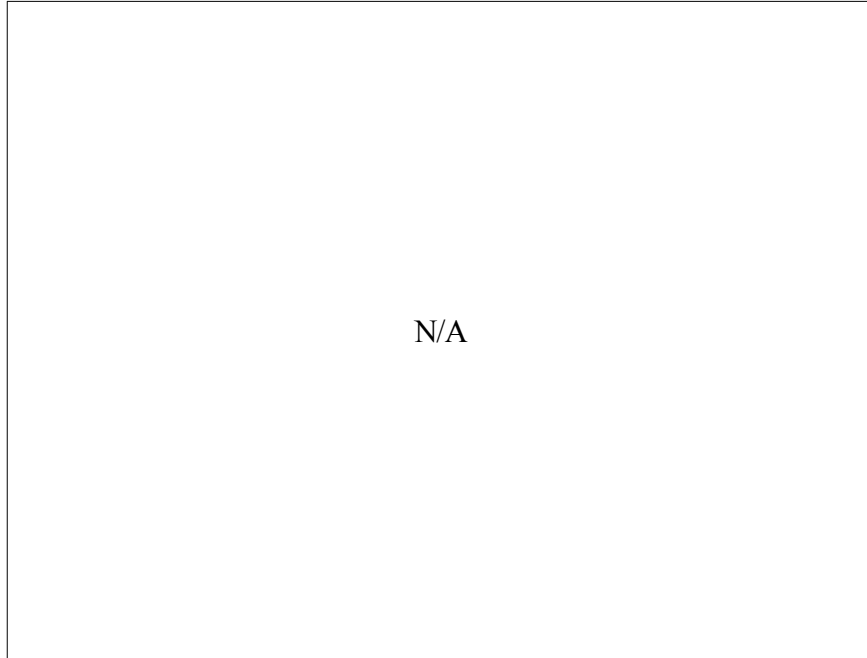

6.4 Electrostatic Discharge Immunity

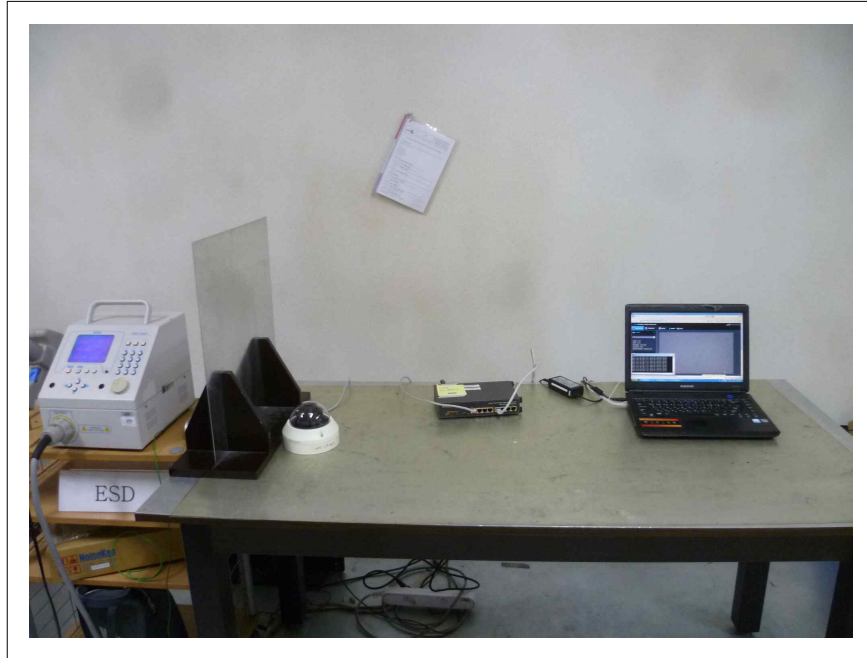

1



2

6.5 Radio frequency electromagnetic field immunity

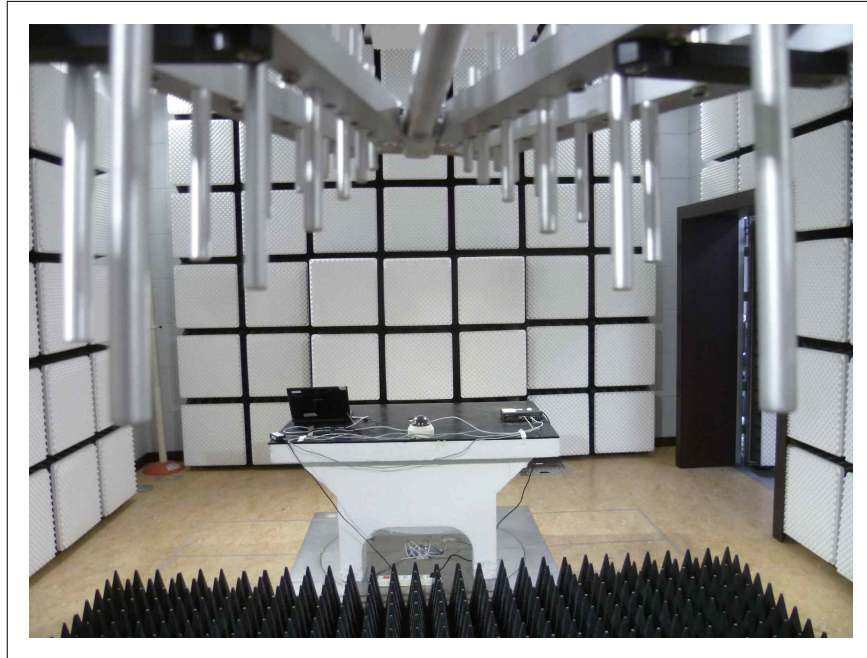

6.6 Fast Transient Immunity



This report shall not be reproduced except in full, without the written approval of KES Co., Ltd.
The test results in the report only apply to the tested sample.

6.7 Surge Immunity



6.8 Radio-frequency continuous conducted Immunity

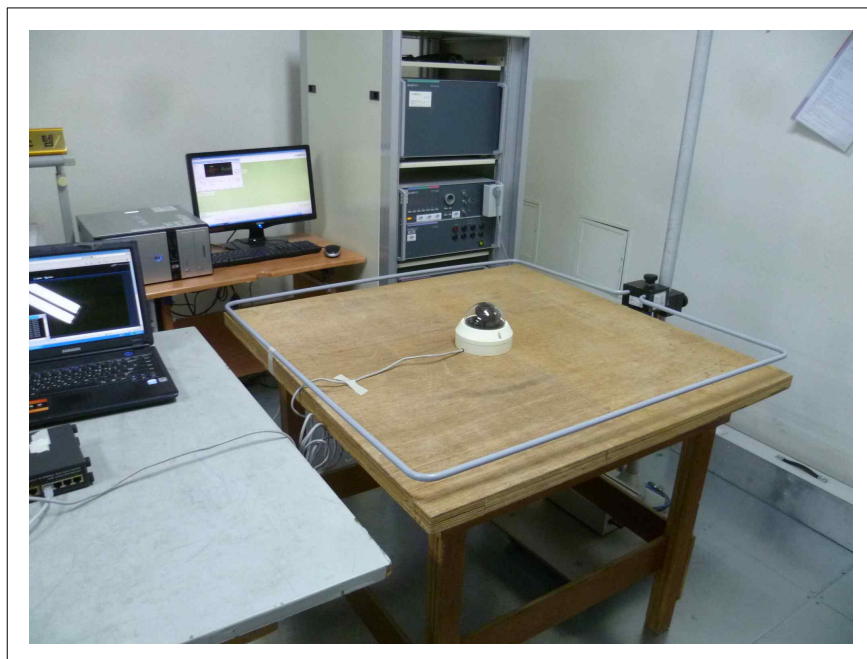

This report shall not be reproduced except in full, without the written approval of KES Co., Ltd.
The test results in the report only apply to the tested sample.

6.9 Voltage Dips and Voltage Interruptions Immunity

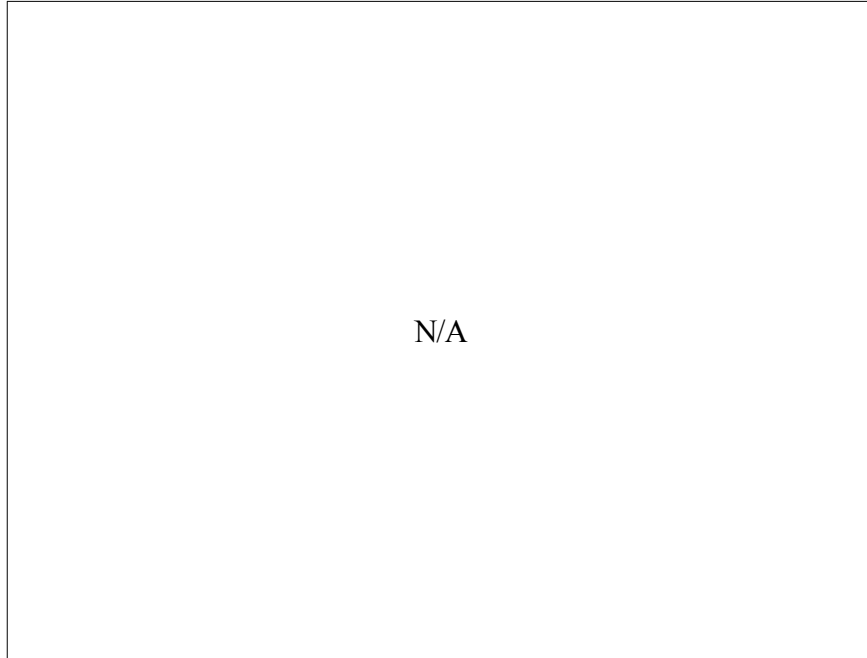

7. External Photographs



[FRONT VIEW]



[REAR VIEW]

This report shall not be reproduced except in full, without the written approval of KES Co., Ltd.
The test results in the report only apply to the tested sample.



[LABEL VIEW]

8. Internal Photographs



[INTERNAL VIEW]

This report shall not be reproduced except in full, without the written approval of KES Co., Ltd.
The test results in the report only apply to the tested sample.

○ Main Board

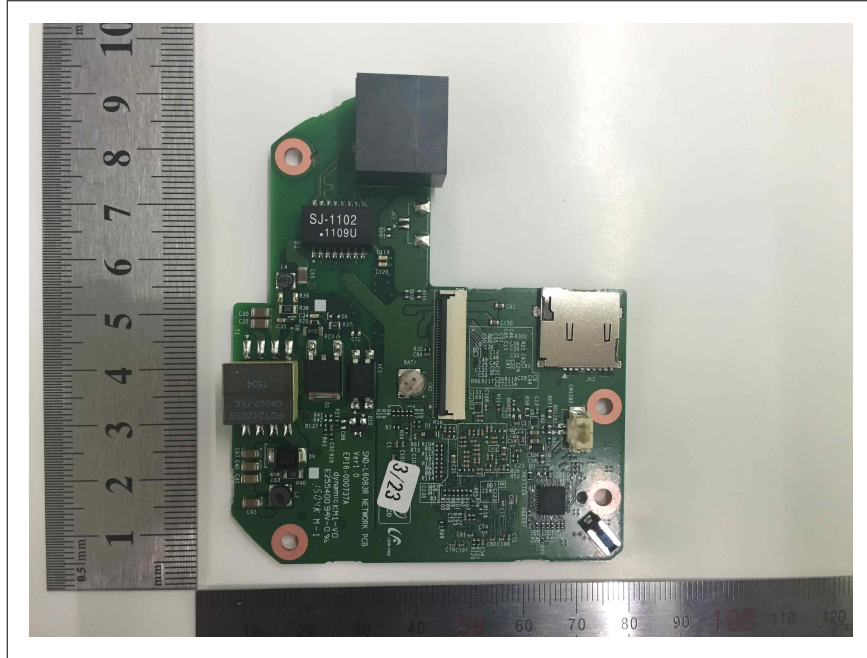

[TOP VIEW]

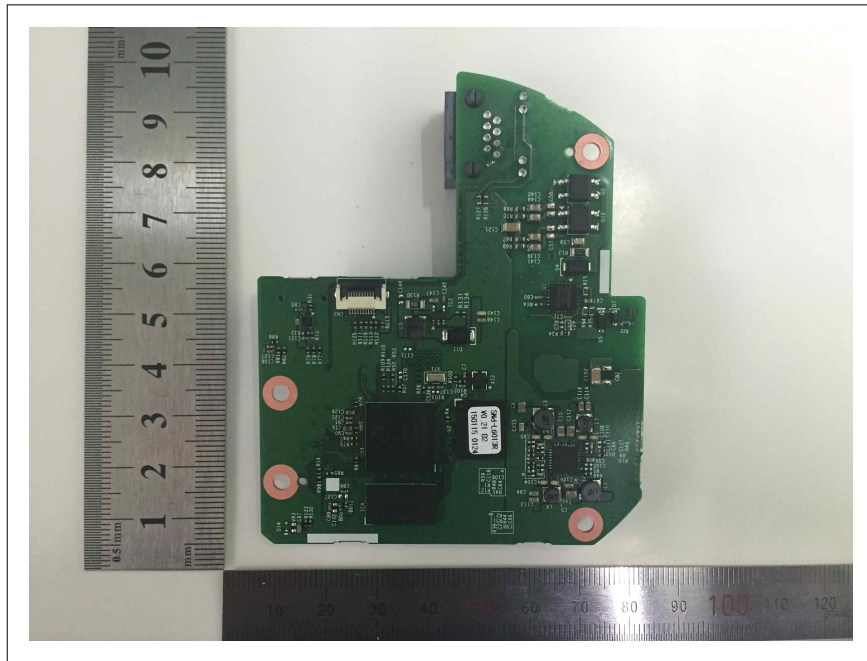

[BOTTOM VIEW]

This report shall not be reproduced except in full, without the written approval of KES Co., Ltd.
The test results in the report only apply to the tested sample.

○ Sensor Board

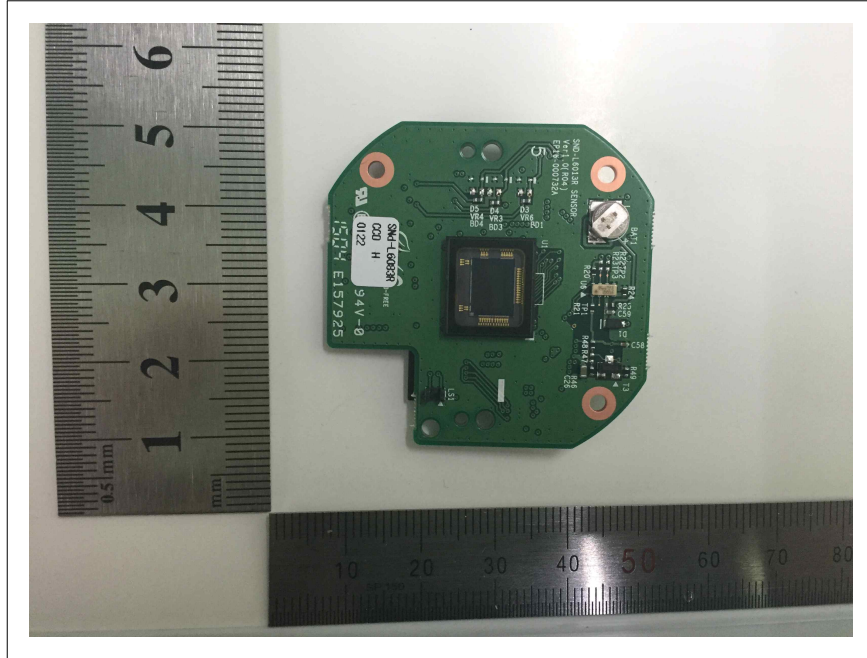

[TOP VIEW]

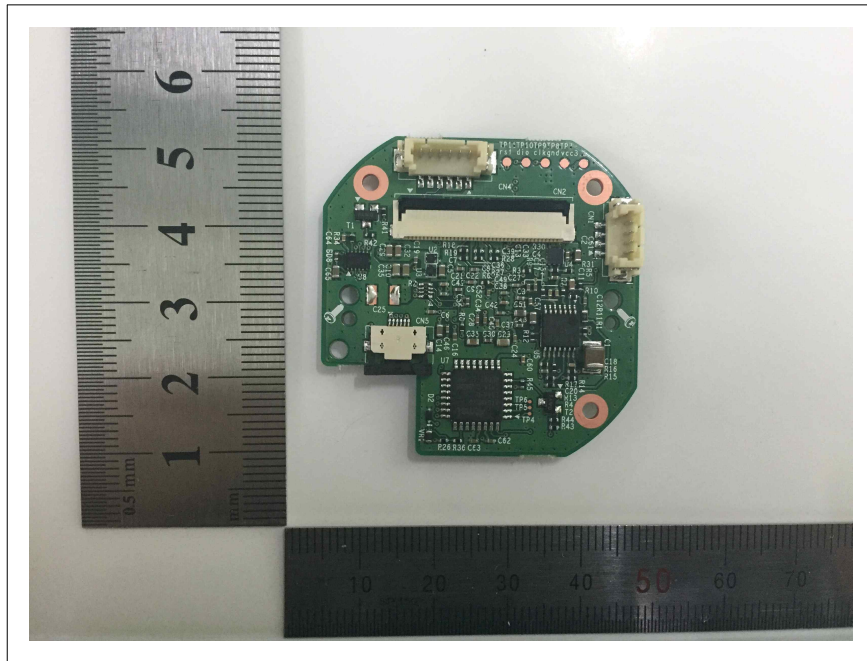

[BOTTOM VIEW]

This report shall not be reproduced except in full, without the written approval of KES Co., Ltd.
The test results in the report only apply to the tested sample.

○ LED Board

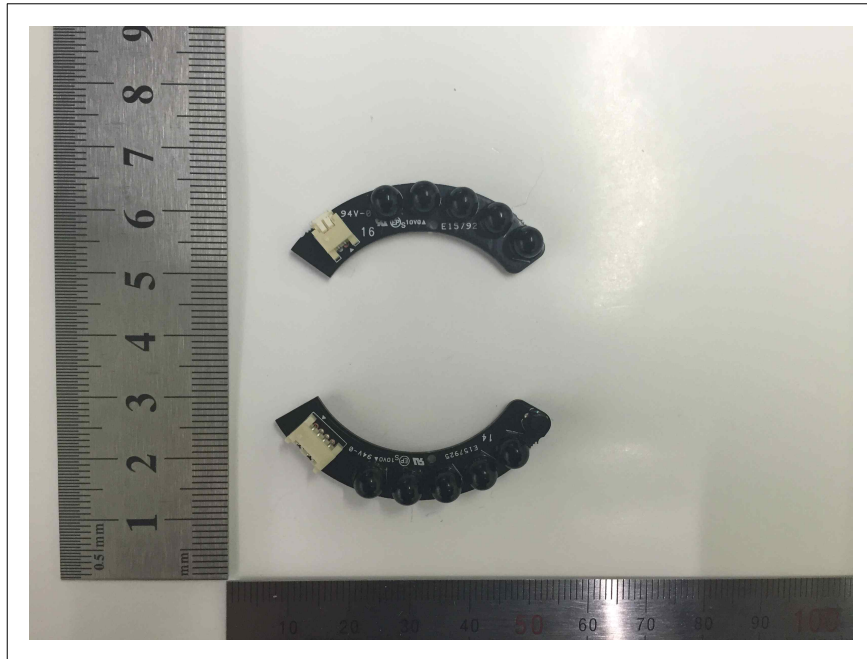

[TOP VIEW]



[BOTTOM VIEW]

This report shall not be reproduced except in full, without the written approval of KES Co., Ltd.
The test results in the report only apply to the tested sample.

○ Lens Module

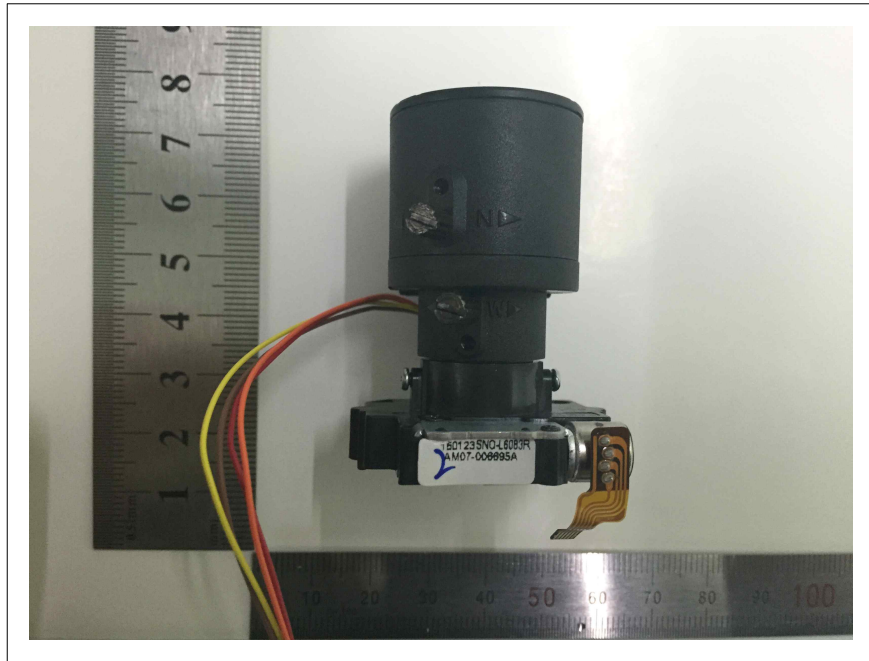

[TOP VIEW]

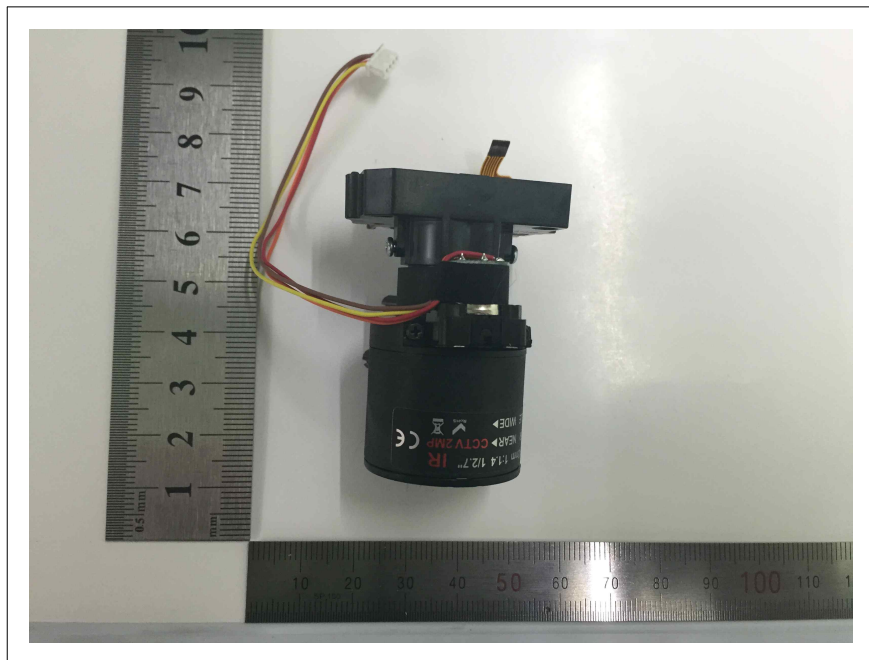

[BOTTOM VIEW]

This report shall not be reproduced except in full, without the written approval of KES Co., Ltd.
The test results in the report only apply to the tested sample.



Appendix A - Schematics/Block Diagram

Please see attached document(s).



Appendix B - User's Manual

Please see attached document(s).